

PUSZKI ELEKTROINSTALACYJNE

- PUSZKI PODTYNKOWE
- PUSZKI HERMETYCZNE
- AKCESORIA



IP 20 650 °C 250 V PP



PUSZKA P/T PK-60F DO ŚCIAN PUSTYCH

Typ	Kolor	Opak.	Waga	Indeks
PK-60 GK	ceglasty RAL 2012	szt. 40	kg/100 szt. 2,50	0201-00

Do montażu osprzętu na wkręty lub na pazurki. Napięcie pracy 250 V.
NORMA: PN-E-93208:1997, PN-EN 60670-1:2007. Rozmiar otworu frezowanego \varnothing 68.
Wymiary: \varnothing 60x głęb. 47 mm

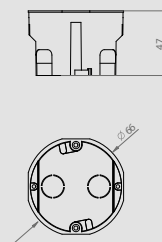

IP 20 650 °C 250 V PP



PUSZKA P/T PK-60F DO ŚCIAN PUSTYCH GŁĘBOKA

Typ	Kolor	Opak.	Waga	Indeks
PK-60 GK	ceglasty RAL 2012	szt. 40	kg/100 szt. 2,70	0220-00

Do montażu osprzętu na wkręty lub na pazurki. Napięcie pracy 250 V.
NORMA: PN-E-93208:1997, PN-EN 60670-1:2007. Rozmiar otworu frezowanego \varnothing 68.
Wymiary: \varnothing 60x głęb. 62 mm

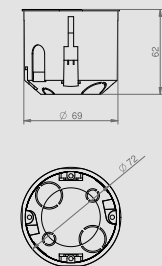

IP 20 650 °C 250 V PP



PUSZKA P/T PO-70F DO ŚCIAN PUSTYCH

Typ	Kolor	Opak.	Waga	Indeks
PO-70 GK	ceglasty RAL 2012	szt. 40	kg/100 szt. 3,30	0204-00

Napięcie pracy 250 V.
NORMA: PN-E-93208:1997, PN-EN 60670-1:2007. Rozmiar otworu frezowanego \varnothing 72-74.
Wymiary: \varnothing 70x głęb. 37 mm

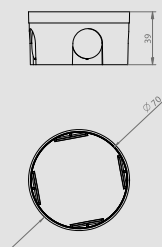

IP 20 650 °C 250 V PP



PUSZKA P/T PO-80F DO ŚCIAN PUSTYCH

Typ	Kolor	Opak.	Waga	Indeks
PO-80 GK	ceglasty RAL 2012	szt. 35	kg/100 szt. 3,60	0209-00

Napięcie pracy 250 V.
NORMA: PN-E-93208:1997, PN-EN 60670-1:2007. Rozmiar otworu frezowanego \varnothing 82-84.
Wymiary: \varnothing 80x głęb. 50 mm

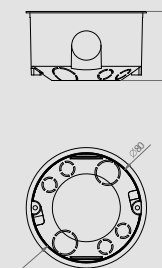

PP



POZYCJONER DO PUSZEK KARTON-GIPS

Typ	Kolor	Opak.	Waga	Indeks
Pozycjoner	szary RAL 7043	szt. 10	kg/100 szt. 4,50	0237-00

Ułatwia trasowanie i wycinanie otworów dla puszek jedno- i wielokrotnych.
Przyrząd posiada wbudowane poziomicę.

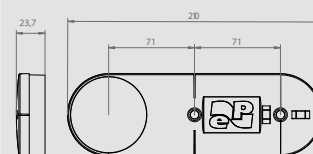

IP 20 650 °C 250 V PP



PUSZKA P/T PK-2X60F DO ŚCIAN PUSTYCH

Typ	Kolor	Opak.	Waga	Indeks
		szt.	kg/100 szt.	
PK-2x60 GK	ceglasty RAL 2012	30	5,30	0210-00

Do montażu osprzętu na wkręty lub na pazurki. Napięcie pracy 250 V.
 NORMA: PN-E-93208:1997, PN-EN 60670-1:2007. Rozmiar otworu frezowanego 2 x Ø 67.
 Wymiary wewnętrzne: 135x61x46 mm
 Wymiary: 2 x Ø 60x głęb. 47 mm
 Możliwość zamówienia w wersji do muru bez łapek do GK i wkrętów pozycjonujących,
 indeks: 0210-10

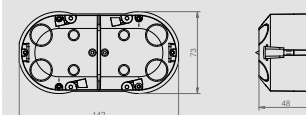

IP 20 650 °C 250 V PP



PUSZKA P/T PK-3X60F DO ŚCIAN PUSTYCH

Typ	Kolor	Opak.	Waga	Indeks
		szt.	kg/100 szt.	
PK-3x60 GK	ceglasty RAL 2012	20	7,60	0234-00

Do montażu osprzętu na wkręty lub na pazurki. Napięcie pracy 250 V.
 NORMA: PN-E-93208:1997, PN-EN 60670-1:2007. Rozmiar otworu frezowanego 3 x Ø 67.
 Wymiary wewnętrzne: 204x61x46 mm
 Wymiary: 3 x Ø 60x głęb. 47 mm
 Możliwość zamówienia w wersji do muru bez łapek do GK i wkrętów pozycjonujących,
 indeks: 0234-10

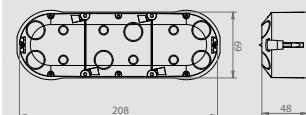

IP 20 650 °C 250 V PP



PUSZKA P/T PK-4X60F DO ŚCIAN PUSTYCH

Typ	Kolor	Opak.	Waga	Indeks
		szt.	kg/100 szt.	
PK-4x60 GK	ceglasty RAL 2012	20	8,80	0235-00

Do montażu osprzętu na wkręty lub na pazurki. Napięcie pracy 250 V.
 NORMA: PN-E-93208:1997, PN-EN 60670-1:2007. Rozmiar otworu frezowanego 4 x Ø 67.
 Wymiary wewnętrzne: 275x61x46 mm
 Wymiary: 4 x Ø 60x 47 mm
 Możliwość zamówienia w wersji do muru bez łapek do GK i wkrętów pozycjonujących,
 indeks: 0234-10

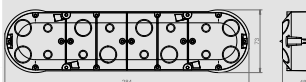

IP 20 650 °C 250 V PP



PUSZKA P/T PK-2X60F DO ŚCIAN PUSTYCH

Typ	Kolor	Opak.	Waga	Indeks
		szt.	kg/100 szt.	
PK-2x60 GK	ceglasty RAL 2012	30	5,30	0286-00

NORMA: PN-E-93208:1997, PN-EN 60670-1:2007
 Do montażu osprzętu na wkręty lub na pazurki. Napięcie znamionowe 250V
 Rozmiar otworu frezowanego 2xØ67
 Wymiary wewnętrzne: 135x54x58 mm
 Wymiary: 2x Ø60 x głęb. 63 mm

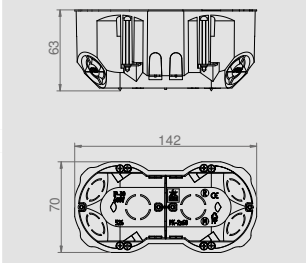

IP 20 650 °C 250 V PP



PUSZKA P/T PK-3X60F DO ŚCIAN PUSTYCH

Typ	Kolor	Opak.	Waga	Indeks
		szt.	kg/100 szt.	
PK-3x60 GK	ceglasty RAL 2012	20	7,60	0287-00

NORMA: PN-E-93208:1997, PN-EN 60670-1:2007
 Do montażu osprzętu na wkręty lub na pazurki. Napięcie znamionowe 250V
 Rozmiar otworu frezowanego 3xØ67
 Wymiary wewnętrzne: 205x54x58 mm
 Wymiary: 3x Ø60 x głęb. 63 mm

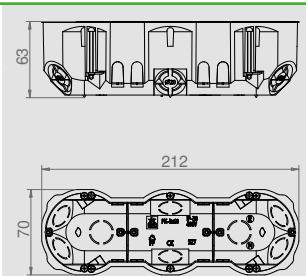

IP 20 650 °C 250 V PP



PUSZKA P/T PK-4X60F DO ŚCIAN PUSTYCH

Typ	Kolor	Opak.	Waga	Indeks
		szt.	kg/100 szt.	
PK-4x60 GK	ceglasty RAL 2012	16	8,80	0288-00

NORMA: PN-E-93208:1997, PN-EN 60670-1:2007
 Do montażu osprzętu na wkręty lub na pazurki. Napięcie znamionowe 250V
 Rozmiar otworu frezowanego 4xØ67
 Wymiary wewnętrzne: 275x54x58 mm
 Wymiary: 4x Ø60 x głęb. 63 mm

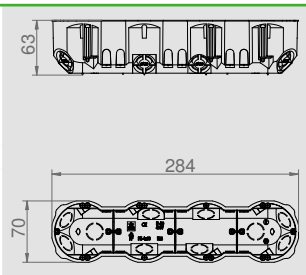

IP 20 850 °C Br Cl 250 V PP



PUSZKA P/T PK-60 DO ŚCIAN PUSTYCH BEZHALOGENOWA SAMOGASNAĆA

Typ	Kolor	Opak.	Waga	Indeks
PK-60 GK	żółty RAL 1021	szt. 40	kg/100 szt. 2,50	0201-0N

Do montażu osprzętu na wkręty lub na pazurki. Napięcie pracy 250 V.
NORMA: PN-E-93208:1997, PN-EN 60670-1:2007. Samogasnąca przy 850°C.
Rozmiar otworu frezowanego \varnothing 68. Wymiary: \varnothing 67x głęb. 47 mm

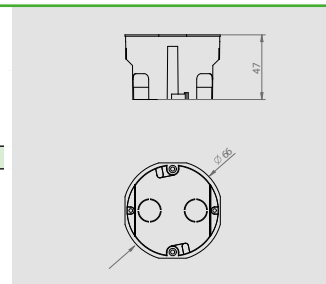

IP 20 850 °C Br Cl 250 V PP



PUSZKA P/T PK-60 DO ŚCIAN PUSTYCH BEZHALOGENOWA SAMOGASNAĆA

Typ	Kolor	Opak.	Waga	Indeks
PK-60 GK	żółty RAL 1021	szt. 40	kg/100 szt. 2,70	0220-0N

Do montażu osprzętu na wkręty lub na pazurki. Napięcie pracy 250 V.
NORMA: PN-E-93208:1997, PN-EN 60670-1:2007. Samogasnąca przy 850°C.
Rozmiar otworu frezowanego \varnothing 68. Wymiary: \varnothing 60x głęb. 62 mm

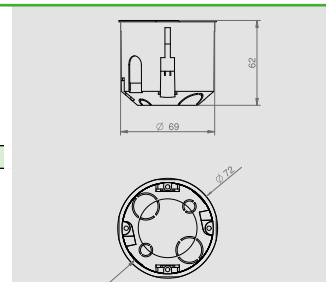

IP 20 850 °C Br Cl 250 V PP



PUSZKA P/T PO-70 DO ŚCIAN PUSTYCH BEZHALOGENOWA SAMOGASNAĆA

Typ	Kolor	Opak.	Waga	Indeks
PO-70 GK	żółty RAL 1021	szt. 40	kg/100 szt. 3,50	0204-0N

Napięcie pracy 250 V.
NORMA: PN-E-93208:1997, PN-EN 60670-1:2007. Samogasnąca przy 850°C.
Rozmiar otworu frezowanego \varnothing 72-74. Wymiary: \varnothing 70x głęb. 47 mm

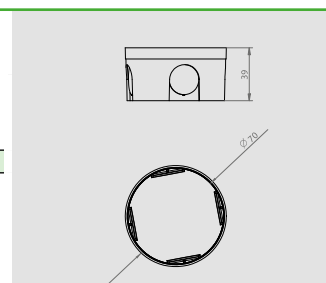

IP 20 850 °C Br Cl 250 V PP



PUSZKA P/T PO-80 DO ŚCIAN PUSTYCH BEZHALOGENOWA SAMOGASNAĆA

Typ	Kolor	Opak.	Waga	Indeks
PO-80 GK	żółty RAL 1021	szt. 35	kg/100 szt. 3,60	0209-0N

Napięcie pracy 250 V.
NORMA: PN-E-93208:1997, PN-EN 60670-1:2007. Samogasnąca przy 850°C.
Rozmiar otworu frezowanego \varnothing 82-84. Wymiary: \varnothing 80x głęb. 50 mm

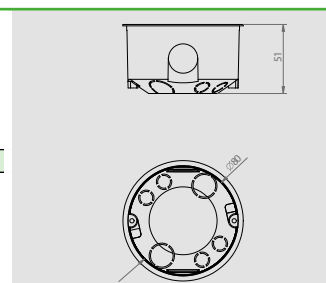



PUSZKA P/T PK-2X60 DO ŚCIAN PUSTYCH BEZHALOGENOWA SAMOGASNAĆA

Typ	Kolor	Opak.	Waga	Indeks
PK-2x60 GK	żółty RAL 1021	szk. 30	kg/100 szk. 5,30	0210-0N

Do montażu osprzętu na wkręty lub na pazurki. Napięcie pracy 250 V.
 NORMA: PN-E-93208:1997, PN-EN 60670-1:2007. Samogasnąca przy 850°C.
 Rozmiar otworu frezowanego $\varnothing 2 \times \varnothing 67$.
 Wymiary wewnętrzne: 135x61x46 mm
 Wymiary: 2x $\varnothing 60$ x głęb. 47 mm

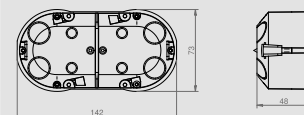

PUSZKA P/T PK-3X60 DO ŚCIAN PUSTYCH BEZHALOGENOWA SAMOGASNAĆA

Typ	Kolor	Opak.	Waga	Indeks
PK-3x60 GK	żółty RAL 1021	szk. 20	kg/100 szk. 7,60	0234-0N

Do montażu osprzętu na wkręty lub na pazurki. Napięcie pracy 250 V.
 NORMA: PN-E-93208:1997, PN-EN 60670-1:2007. Samogasnąca przy 850°C.
 Rozmiar otworu frezowanego $3 \times \varnothing 67$.
 Wymiary wewnętrzne: 204x61x46 mm
 Wymiary: 3x $\varnothing 60$ x głęb. 47 mm

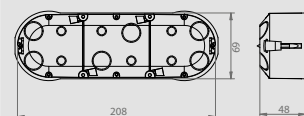

PUSZKA P/T PK-4X60 DO ŚCIAN PUSTYCH BEZHALOGENOWA SAMOGASNAĆA

Typ	Kolor	Opak.	Waga	Indeks
PK-4x60 GK	żółty RAL 1021	szk. 20	kg/100 szk. 8,80	0235-0N

Do montażu osprzętu na wkręty lub na pazurki. Napięcie pracy 250 V.
 NORMA: PN-E-93208:1997, PN-EN 60670-1:2007. Samogasnąca przy 850°C.
 Rozmiar otworu frezowanego $4 \times \varnothing 67$.
 Wymiary wewnętrzne: 275x61x46 mm
 Wymiary: 4x $\varnothing 60$ x głęb. 47 mm

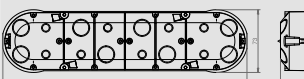

PUSZKA P/T PK-2X60F DO ŚCIAN PUSTYCH BEZHALOGENOWA SAMOGASNAĆA

Typ	Kolor	Opak.	Waga	Indeks
PK-2x60 GK	żółty RAL 1021	szk. 30	kg/100 szk. 5,30	0286-0N

NORMA: PN-E-93208:1997, PN-EN 60670-1:2007
 Do montażu osprzętu na wkręty lub na pazurki. Napięcie znamionowe 250V
 Rozmiar otworu frezowanego $2 \times \varnothing 67$
 Wymiary wewnętrzne: 135x54x58 mm
 Wymiary: 2x $\varnothing 60$ x głęb. 63 mm

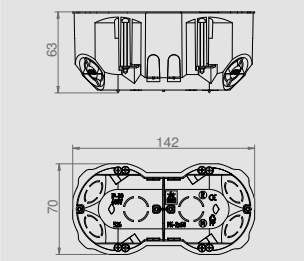

PUSZKA P/T PK-3X60F DO ŚCIAN PUSTYCH BEZHALOGENOWA SAMOGASNAĆA

Typ	Kolor	Opak.	Waga	Indeks
PK-3x60 GK	żółty RAL 1021	szk. 20	kg/100 szk. 7,60	0287-0N

NORMA: PN-E-93208:1997, PN-EN 60670-1:2007
 Do montażu osprzętu na wkręty lub na pazurki. Napięcie znamionowe 250V
 Rozmiar otworu frezowanego $3 \times \varnothing 67$
 Wymiary wewnętrzne: 205x54x58 mm
 Wymiary: 3x $\varnothing 60$ x głęb. 63 mm

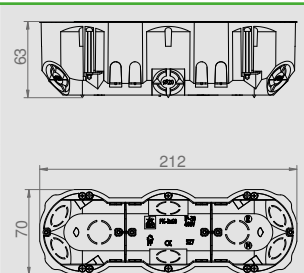

PUSZKA P/T PK-4X60F DO ŚCIAN PUSTYCH BEZHALOGENOWA SAMOGASNAĆA

Typ	Kolor	Opak.	Waga	Indeks
PK-4x60 GK	żółty RAL 1021	szk. 16	kg/100 szk. 8,80	0288-0N

NORMA: PN-E-93208:1997, PN-EN 60670-1:2007
 Do montażu osprzętu na wkręty lub na pazurki. Napięcie znamionowe 250V
 Rozmiar otworu frezowanego $4 \times \varnothing 67$
 Wymiary wewnętrzne: 275x54x58 mm
 Wymiary: 4x $\varnothing 60$ x głęb. 63 mm

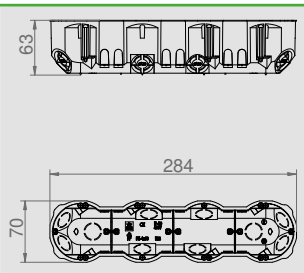

IP 20 650 °C 250 V PP



PUSZKA P/T PK-60F PRO

Typ	Kolor	Opak.	Waga	Indeks
PK-60 PRO	ceglasty RAL 2012	szt. 100	kg/100 szt. 1,20	0281-00

Do montażu osprzętu na wkręty lub na pazurki. Napięcie pracy 250 V.
NORMA: PN-E-93208:1997, PN-EN 60670-1:2007. Bez wkrętów pozycjonujących osprzęt.
Wymiary wewnętrzne: 60x40 mm
Wymiary: Ø 60x głęb. 41 mm

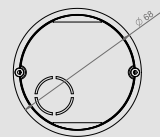
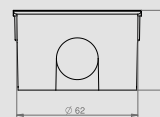

IP 20 650 °C 250 V PP



PUSZKA P/T PK-60F PRO Z WKRĘTAMI

Typ	Kolor	Opak.	Waga	Indeks
PK-60 PRO	ceglasty RAL 2012	szt. 100	kg/100 szt. 1,30	0281-01

Do montażu osprzętu na wkręty lub na pazurki. Napięcie pracy 250 V.
NORMA: PN-E-93208:1997, PN-EN 60670-1:2007. Zawiera wkręty pozycjonujące osprzęt.
Wymiary wewnętrzne: 60x40 mm
Wymiary: Ø 60x głęb. 41 mm

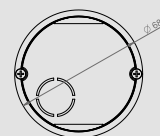

IP 20 650 °C 250 V PP



PUSZKA P/T PK-60F LUX POGŁĘBIANA

Typ	Kolor	Opak.	Waga	Indeks
PK-60 LUX	ceglasty RAL 2012	szt. 60	kg/100 szt. 1,80	0206-50

Do montażu osprzętu na wkręty lub na pazurki. Napięcie pracy 250 V.
NORMA: PN-E-93208:1997, PN-EN 60670-1:2007.
Pogłębiana bez wkrętów pozycjonujących osprzęt.
Wymiary wewnętrzne: 60x62 mm
Wymiary: Ø 60x głęb. 63 mm

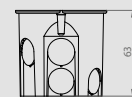

IP 20 650 °C 250 V PP



PUSZKA P/T PK-60F LUX POGŁĘBIANA Z WKRĘTAMI

Typ	Kolor	Opak.	Waga	Indeks
PK-60 LUX	ceglasty RAL 2012	szt. 60	kg/100 szt. 1,93	0206-51

Do montażu osprzętu na wkręty lub na pazurki. Napięcie pracy 250 V.
NORMA: PN-E-93208:1997, PN-EN 60670-1:2007.
Pogłębiana zawiera wkręty pozycjonujące osprzęt.
Wymiary: Ø 60x głęb. 63 mm

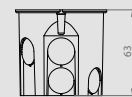

IP 20 650 °C 250 V PP



PUSZKA P/T PO-70F PRO

Typ	Kolor	Opak.	Waga	Indeks
PO-70 PRO	ceglasty RAL 2012	szt. 60	kg/100 szt. 2,70	0282-00

Napięcie pracy 250 V.
NORMA: PN-E-93208:1997, PN-EN 60670-1:2007. Pokrywa w komplecie.
Wymiary wewnętrzne: 70x37 mm
Wymiary: Ø 70x głęb. 37 mm

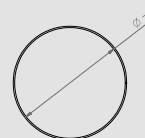
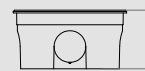

IP 20 650 °C 250 V PP



PUSZKA P/T PO-80F PRO

Typ	Kolor	Opak.	Waga	Indeks
PO-80 PRO	ceglasty RAL 2012	szt. 50	kg/100 szt. 3,35	0283-00

Napięcie pracy 250 V.
NORMA: PN-E-93208:1997, PN-EN 60670-1:2007. Pokrywa w komplecie.
Wymiary wewnętrzne: 70x37 mm
Wymiary: Ø 80x głęb. 50 mm

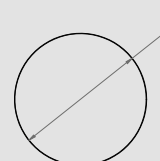

IP 20 650 °C 250 V PP



PUSZKA P/T PK-60F PRO ŁĄCZENIOWA PŁYTKA

Typ	Kolor	Opak.	Waga	Indeks
PK-60 PRO	ceglasty RAL 2012	szt. 90	kg/100 szt. 1,45	0284-00

Do montażu osprzętu na wkręty lub na pazurki. Napięcie pracy 250 V.
 NORMA: PN-E-93208:1997, PN-EN 60670-1:2007. Łączeniowa płytka bez wkrętów pozycjonujących osprzęt.
 Wymiary wewnętrzne: 60x41 mm
 Wymiary: Ø 60x głęb. 41 mm

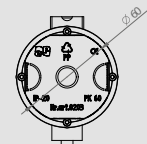
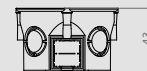

IP 20 650 °C 250 V PP



PUSZKA P/T PK-60F PRO ŁĄCZENIOWA PŁYTKA Z WKREŃTAMI

Typ	Kolor	Opak.	Waga	Indeks
PK-60 PRO	ceglasty RAL 2012	szt. 90	kg/100 szt. 1,56	0284-01

Do montażu osprzętu na wkręty lub na pazurki. Napięcie pracy 250 V.
 NORMA: PN-E-93208:1997, PN-EN 60670-1:2007. Łączeniowa płytka zawiera wkręty pozycjonujące osprzęt.
 Wymiary wewnętrzne: 60x41 mm
 Wymiary: Ø 60x głęb. 41 mm

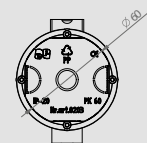

IP 20 650 °C 250 V PP



PUSZKA P/T PK-60F PRO ŁĄCZENIOWA GŁĘBOKA

Typ	Kolor	Opak.	Waga	Indeks
PK-60 PRO	ceglasty RAL 2012	szt. 60	kg/100 szt. 1,91	0285-00

Do montażu osprzętu na wkręty lub na pazurki. Napięcie pracy 250 V.
 NORMA: PN-E-93208:1997, PN-EN 60670-1:2007. Łączeniowa głęboka bez wkrętów pozycjonujących osprzęt.
 Wymiary wewnętrzne: 60x62 mm
 Wymiary: Ø 60x głęb. 61 mm

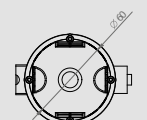
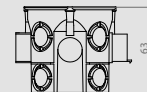

IP 20 650 °C 250 V PP



PUSZKA P/T PK-60F PRO ŁĄCZENIOWA GŁĘBOKA Z WKREŃTAMI

Typ	Kolor	Opak.	Waga	Indeks
PK-60 PRO	ceglasty RAL 2012	szt. 60	kg/100 szt. 1,95	0285-01

Do montażu osprzętu na wkręty lub na pazurki. Napięcie pracy 250 V.
 NORMA: PN-E-93208:1997, PN-EN 60670-1:2007. Łączeniowa głęboka zawiera wkręty pozycjonujące osprzęt.
 Wymiary wewnętrzne: 60x62 mm
 Wymiary: Ø 60x głęb. 61 mm

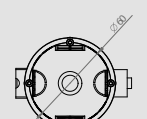
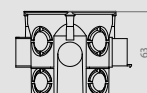

IP 20 650 °C 250 V PP



PUSZKA P/T PK-60F

Typ	Kolor	Opak.	Waga	Indeks
PK-60F	czarny RAL 9005	szt. 100	kg/100 szt. 1,20	0202-00

Do montażu osprzętu na wkręty lub na pazurki. Napięcie pracy 250 V.
NORMA: PN-E-93208:1997, PN-EN 60670-1:2007.
Wymiary wewnętrzne: 61x41 mm
Wymiary: Ø 60x głęb. 41 mm

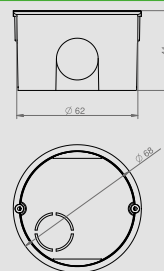

IP 20 650 °C 250 V PP



PUSZKA P/T PO-70F

Typ	Kolor	Opak.	Waga	Indeks
PO-70F	czarny RAL 9005	szt. 60	kg/100 szt. 2,70	0205-00

Napięcie pracy 250 V.
NORMA: PN-E-93208:1997, PN-EN 60670-1:2007. Dekiel w komplecie.
Wymiary wewnętrzne: 61x41 mm
Wymiary: Ø 70x głęb. 37 mm

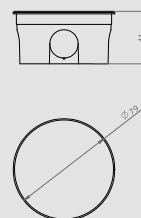

IP 20 650 °C 250 V PP



PUSZKA P/T PO-80F

Typ	Kolor	Opak.	Waga	Indeks
PO-80F	czarny RAL 9005	szt. 50	kg/100 szt. 3,35	0207-00

Napięcie pracy 250 V.
NORMA: PN-E-93208:1997, PN-EN 60670-1:2007. Dekiel w komplecie.
Wymiary wewnętrzne: 79x45 mm
Wymiary: Ø 80x głęb. 50 mm

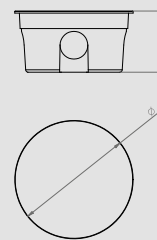

IP 44 650 °C 400 V PE

NOWOŚĆ



PUSZKA DO PODŁĄCZEŃ PODTYNKOWYCH AGD

Typ	Kolor	Opak.	Waga	Indeks
Puszka AGD	biały RAL 9003	szt. 10	kg/100 szt. 4,25	3040115

NORMA: PN-E-93208:1997, PN-EN 60670-1:2007.
Wyposażenie: zacisk 5x(2x2,5mm²) 400V
Wymiary: 82mm wys. x 82mm szer. x 21mm głęb.
Stosowana przy podłączeniach urządzeń AGD, płyt indukcyjnych 3 – fazowych.

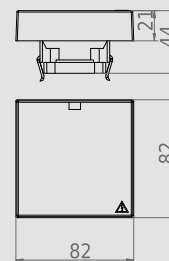

Puszka AGD



650 °C PP



POKRYWA PUSZKI Ø60

Typ	Kolor	Opak.	Waga	Indeks
		szt.	kg/100 szt.	
Pokrywa puszki	biały RAL 9003	50	1,10	028404-00

Służy do zamaskowania puszki.

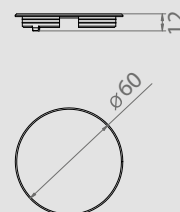

650 °C PP



POKRYWA PUSZKI Ø70

Typ	Kolor	Opak.	Waga	Indeks
		szt.	kg/100 szt.	
Pokrywa puszki	biały RAL 9003	100	1,20	020502-00

Służy do zamaskowania puszki.

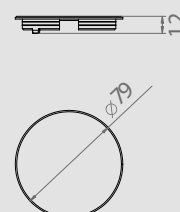

650 °C PP



POKRYWA PUSZKI Ø80

Typ	Kolor	Opak.	Waga	Indeks
		szt.	kg/100 szt.	
Pokrywa puszki	biały RAL 9003	100	1,30	020902-00

Służy do zamaskowania puszki.

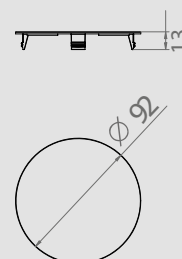

650 °C PS



POKRYWA PUSZKI Ø70/Ø80 UNIWERSALNA

Typ	Kolor	Opak.	Waga	Indeks
		szt.	kg/100 szt.	
Pokrywa puszki	biały RAL 9003	200	1,10	3313-00

Służy do zamaskowania puszki.

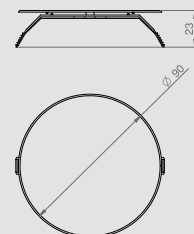

650 °C PE



POKRYWA SYGNALIZACYJNA Z WĄSAMAMI

Typ	Kolor	Opak.	Waga	Indeks
		szt.	kg/100 szt.	
Pokrywa puszki	ceglasty RAL2012	100	0,45	0202-02

Pokrywa służy do zabezpieczenia wnętrza puszki podczas tynkowania ściany

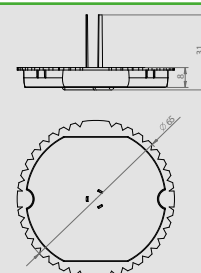

IP 20 650 °C 250 V PP



PIERŚCIEŃ DYSTANSOWY DO PUSZEK PK60 12 MM

Typ	Kolor	Opak.	Waga	Indeks
Pierścień	ceglasty RAL2012	50 szt.	0,72 kg/100 szt.	028402-00

NORMA: PN-E-93208:1997, PN-EN 60670-1:2007.
Wymiary: Ø 60x wys. 12 mm

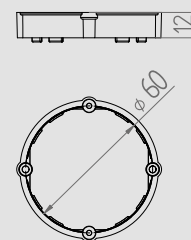

IP 20 650 °C 250 V PP



PIERŚCIEŃ DYSTANSOWY DO PUSZEK PK60 12 MM Z/ WKRĘTAMI

Typ	Kolor	Opak.	Waga	Indeks
Pierścień	ceglasty RAL2012	50 szt.	0,82 kg/100 szt.	028402-01

NORMA: PN-E-93208:1997, PN-EN 60670-1:2007.
Pierścień zawiera wkręty pozycjonujące osprzęt.
Wymiary: Ø 60x wys. 12 mm

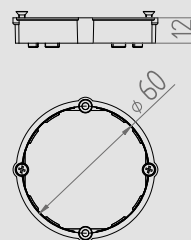

IP 20 650 °C 250 V PP



PIERŚCIEŃ DYSTANSOWY DO PUSZEK PK60 24 MM

Typ	Kolor	Opak.	Waga	Indeks
Pierścień	ceglasty RAL2012	50 szt.	1,2 kg/100 szt.	028403-00

NORMA: PN-E-93208:1997, PN-EN 60670-1:2007.
Wymiary: Ø 60x wys. 24 mm

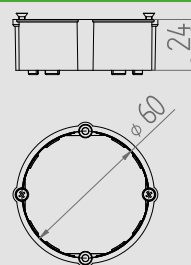

IP 20 650 °C 250 V PP



PIERŚCIEŃ DYSTANSOWY DO PUSZEK PK60 24 MM Z WKRĘTAMI

Typ	Kolor	Opak.	Waga	Indeks
Pierścień	ceglasty RAL2012	50 szt.	1,3 kg/100 szt.	028403-01

NORMA: PN-E-93208:1997, PN-EN 60670-1:2007.
Pierścień zawiera wkręty pozycjonujące osprzęt.
Wymiary: Ø 60x wys. 24 mm

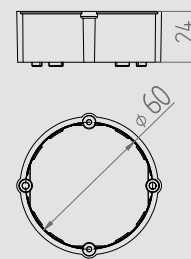

IP 40 650 °C 400 V PP



INSTALL-BOX PUSZKA INSTALACYJNA P/T DO ŚCIAN PUSTYCH 89X89X50

Typ	Kolor	Opak.	Waga	Indeks
		szt.	kg/100 szt.	
Install-Box KG	ceglasty RAL 2012	36	5,50	0260-00
Install-Box KGS 850°C	żółty RAL 1021	36	5,50	0260-0N

Napięcie pracy 400V.
Posiada pazurki do montażu w ścianach pustych.
NORMA: PN-E-93208:1997, PN-EN 60670-1:2007. Wymiary wewnętrzne: 77x77x49 mm
Wymiary dna: 89x89x50 mm.

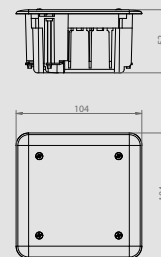

IP 40 650 °C 400 V PP



INSTALL-BOX PUSZKA INSTALACYJNA P/T DO ŚCIAN PUSTYCH 95X95X50

Typ	Kolor	Opak.	Waga	Indeks
		szt.	kg/100 szt.	
Install-Box KG	ceglasty RAL 2012	30	7,40	0261-00
Install-Box KGS 850°C	żółty RAL 1021	30	7,40	0261-0N

Napięcie pracy 400V.
Posiada pazurki do montażu w ścianach pustych.
NORMA: PN-E-93208:1997, PN-EN 60670-1:2007. Wymiary wewnętrzne: 87x87x49 mm
Wymiary dna: 98x98x50 mm.

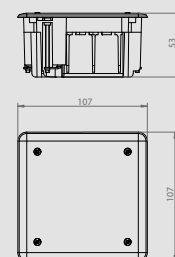

IP 40 650 °C 400 V PP



INSTALL-BOX PUSZKA INSTALACYJNA P/T DO ŚCIAN PUSTYCH 105X105X50

Typ	Kolor	Opak.	Waga	Indeks
		szt.	kg/100 szt.	
Install-Box KG	ceglasty RAL 2012	24	8,50	0262-00
Install-Box KGS 850°C	żółty RAL 1021	24	8,50	0262-0N

Napięcie pracy 400V.
Posiada pazurki do montażu w ścianach pustych.
NORMA: PN-E-93208:1997, PN-EN 60670-1:2007. Wymiary wewnętrzne: 93x93x49 mm
Wymiary dna: 105x105x50 mm

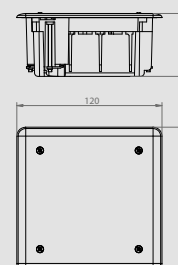

IP 40 650 °C 400 V PP

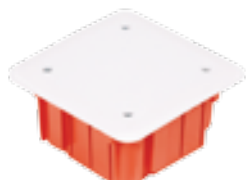

INSTALL-BOX PUSZKA INSTALACYJNA P/T 89X89X50

Typ	Kolor	Opak.	Waga	Indeks
		szt.	kg/100 szt.	
Install-Box	ceglasty RAL 2012	36	5,40	0260-01

Napięcie pracy 400 V.
NORMA: PN-E-93208:1997, PN-EN 60670-1:2007.
Wymiary wewnętrzne: 77x77x49 mm
Wymiary dna: 89x89x50 mm

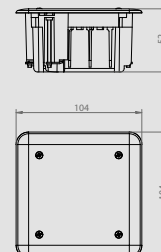

IP 40 650 °C 400 V PP

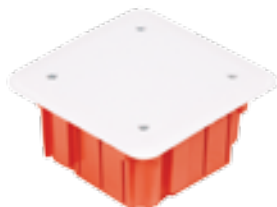

INSTALL-BOX PUSZKA INSTALACYJNA P/T 95X95X50

Typ	Kolor	Opak.	Waga	Indeks
		szt.	kg/100 szt.	
Install-Box	ceglasty RAL 2012	30	7,20	0261-01

Napięcie pracy 400V.
NORMA: PN-E-93208:1997, PN-EN 60670-1:2007.
Wymiary wewnętrzne: 87x87x49 mm
Wymiary dna: 98x98x50 mm

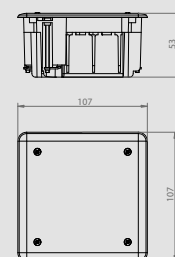

IP 40 650 °C 400 V PP

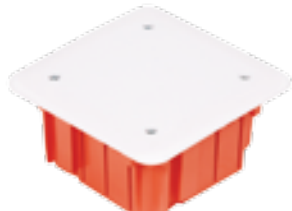

INSTALL-BOX PUSZKA INSTALACYJNA P/T 105X105X50

Typ	Kolor	Opak.	Waga	Indeks
		szt.	kg/100 szt.	
Install-Box	ceglasty RAL 2012	24	8,40	0262-01

Napięcie pracy 400V.
NORMA: PN-E-93208:1997, PN-EN 60670-1:2007.
Wymiary wewnętrzne: 93x93x49 mm
Wymiary dna: 105x105x50 mm

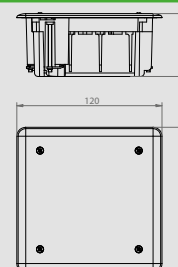

IP 40 650 °C 400 V PP



INSTALL-BOX PUSZKA INSTALACYJNA P/T 130X100X70

Typ	Kolor	Opak.	Waga	Indeks
-----	-------	-------	------	--------

Install-Box	ceglasty RAL 2012	14 szt.	15,00 kg/100 szt.	0263-01
-------------	-------------------	---------	-------------------	---------

Napięcie pracy 400 V.
NORMA: PN-E-93208:1997, PN-EN 60670-1:2007.
Wymiary wewnętrzne: 128x89x68 mm
Wymiary dna: 144x104x74 mm

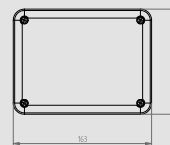

IP 40 650 °C 400 V PP



INSTALL-BOX PUSZKA INSTALACYJNA P/T 185X185X70

Typ	Kolor	Opak.	Waga	Indeks
-----	-------	-------	------	--------

Install-Box	ceglasty RAL 2012	5 szt.	28,00 kg/100 szt.	0264-01
-------------	-------------------	--------	-------------------	---------

Napięcie pracy 400V.
NORMA: PN-E-93208:1997, PN-EN 60670-1:2007.
Wymiary wewnętrzne: 170x170x68 mm
Wymiary dna: 185x185x75 mm

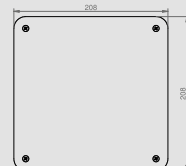
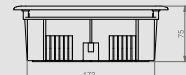

IP 40 650 °C 400 V PP



INSTALL-BOX PUSZKA INSTALACYJNA P/T 264X177X76

Typ	Kolor	Opak.	Waga	Indeks
-----	-------	-------	------	--------

Install-Box	ceglasty RAL 2012	5 szt.	35,00 kg/100 szt.	0265-01
-------------	-------------------	--------	-------------------	---------

Napięcie pracy 400V.
NORMA: PN-E-93208:1997, PN-EN 60670-1:2007.
Wymiary wewnętrzne: 249x162x68 mm
Wymiary dna: 264x177x76 mm

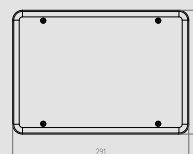

IP 40 650 °C 400 V PS

NOWOŚĆ



INSTALL-BOX PUSZKA INSTALACYJNA P/T 292X213X60

Typ	Kolor	Opak.	Waga	Indeks
-----	-------	-------	------	--------

Install-Box	ceglasty RAL 2012	1 szt.	36,20 kg/100 szt.	0267-01
-------------	-------------------	--------	-------------------	---------

Napięcie pracy 400V.
NORMA: PN-E-93208:1997, PN-EN 60670-1:2007.
Wymiary zewnętrzne dna: 292x213x60 mm
Wymiar pokrywy : 320x257 mm

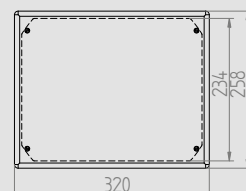

IP 40 650 °C 400 V PP



PUSZKA DO ZŁĄCZA ODGROMOWEGO

Typ	Kolor	Opak.	Waga	Indeks
-----	-------	-------	------	--------

PZO	ceglasty RAL 2012	5 szt.	32,20 kg/100 szt.	0266-00
-----	-------------------	--------	-------------------	---------

Napięcie pracy 400V. NORMA: PN-E-93208:1997, PN-EN 60670-1:2007.
Zabezpiecza złącze instalacji odgromowej przed działaniem warunków atmosferycznych.
Puszka posiada regulację wysokości. W ściankach posiada „wsuwki” ułatwiające zamocowanie puszki bez demontażu złącza instalacji odgromowej.
Powierzchnia pokrywy – matowa.
Wymiary wewnętrzne: 163x163x71 mm
Wymiary dna: 185x185x80 mm
Wzór zastrzeżony w UP-RP

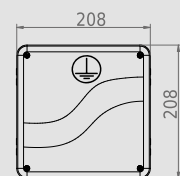
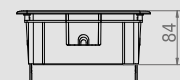

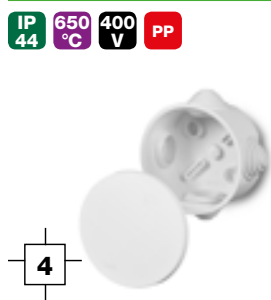

FAST-BOX PUSZKA Ø 65X35 IP 44

Typ	Kolor	Opak.	Waga	Indeks
		szt.	kg/100 szt.	
Fast-Box IP 44	biały RAL 9003	20	4,30	0240-00
	szary RAL 7035*	20	4,30	0240-04

Szybki montaż. NORMA: PN-IEC-60998-1:2006. Ilość wejść: 4 – dławnice.
Wymiary wewnętrzne: 65x36 mm
Wymiary: Ø 75 x 40 mm

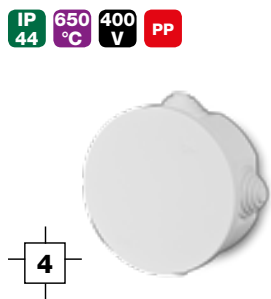
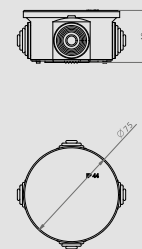

FAST-BOX PUSZKA Ø 80X40 IP 44

Typ	Kolor	Opak.	Waga	Indeks
		szt.	kg/100 szt.	
Fast-Box IP 44	biały RAL 9003	20	5,10	0241-00
	szary RAL 7035*	20	5,10	0241-04

Szybki montaż. NORMA: PN-IEC-60998-1:2006. Ilość wejść: 4 – dławnice.
Wymiary wewnętrzne: 80x40 mm
Wymiary: Ø 90 x 44 mm

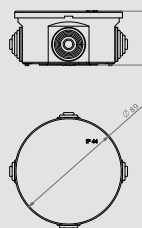

FAST-BOX PUSZKA 70X70X40 IP 44

Typ	Kolor	Opak.	Waga	Indeks
		szt.	kg/100 szt.	
Fast-Box IP44	biały RAL 9003	12	5,60	0245-00
	szary RAL 7035*	12	5,60	0245-04

Szybki montaż. NORMA: PN-IEC-60998-1:2006. Ilość wejść: 6 – dławnic.
Wymiary wewnętrzne: 67x67x41 mm
Wymiary: 78x78x44mm

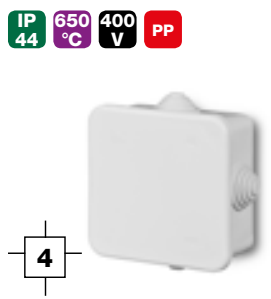
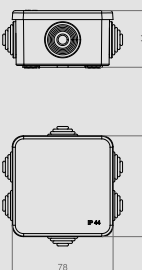

FAST-BOX PUSZKA 80X80X42 IP 44

Typ	Kolor	Opak.	Waga	Indeks
		szt.	kg/100 szt.	
Fast-Box IP 44	biały RAL 9003	24	7,30	0242-00
	szary RAL 7035*	24	7,30	0242-04

Szybki montaż. NORMA: PN-IEC-60998-1:2006. Ilość wejść: 4 – dławnice.
Wymiary wewnętrzne: 80x80x42 mm
Wymiary: 90x90x50 mm

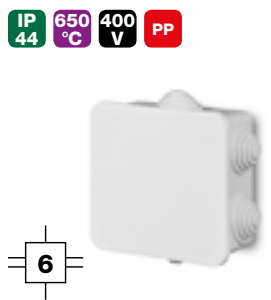
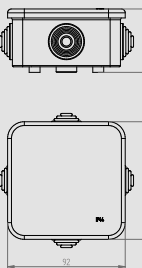

FAST-BOX PUSZKA 76X76X40 IP 44

Typ	Kolor	Opak.	Waga	Indeks
		szt.	kg/100 szt.	
Fast-Box IP 44	biały RAL 9003	12	6,12	0242-10
	szary RAL 7035*	12	6,12	0242-14

Szybki montaż. NORMA: PN-IEC-60998-1:2006. Ilość wejść: 6 – dławnic.
Wymiary wewnętrzne: 76x76x40 mm
Wymiary: 87x87x45 mm

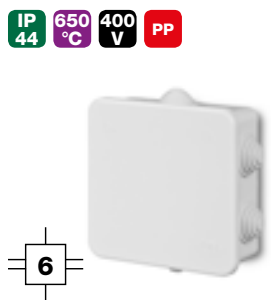
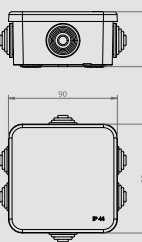

FAST-BOX PUSZKA 110X110X52 IP 44

Typ	Kolor	Opak.	Waga	Indeks
		szt.	kg/100 szt.	
Fast-Box IP 44	biały RAL 9003	9	10,30	0243-00
	szary RAL 7035*	9	10,30	0243-04

Szybki montaż. NORMA: PN-IEC-60998-1:2006. Ilość wejść: 6 – dławnic.
Wymiary wewnętrzne: 100x100x42 mm
Wymiary: 110x110x50 mm

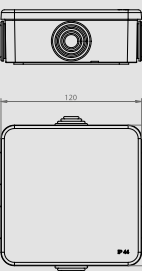

* - na zamówienie indywidualne

IP 55 650 °C 400 V PP

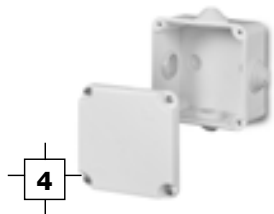

PUSZKA N/T HERMETYCZNA PK-0 EP-LUX IP 55

Typ	Kolor	Opak.	Waga	Indeks
		szt.	kg/100 szt.	
PK-0	biały RAL 9003	20	10,53	0224-00
	szary RAL 7035*	20	10,53	0224-04

NORMA: PN-IEC-60998-1:2006. Ilość wejść: 4 – dławnice.
Wymiary wewnętrzne: 89x89x41 mm
Wymiary: 92x92x50 mm

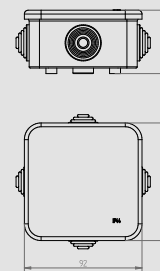

IP 55 650 °C 400 V PP



PUSZKA N/T HERMETYCZNA PK-0 EP-LUX Z WKŁADEM 5X2,5MM² IP 55

Typ	Kolor	Opak.	Waga	Indeks
		szt.	kg/100 szt.	
PK-0	biały RAL 9003	20	10,53	0223-00
	szary RAL 7035*	20	10,53	0223-04

NORMA: PN-IEC-60998-1:2006. Ilość wejść: 4 – dławnice.
Wymiary wewnętrzne: 89x89x41 mm
Wymiary: 92x92x50 mm

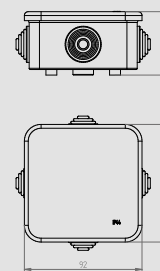

IP 55 650 °C 400 V PP



PUSZKA N/T HERMETYCZNA PK-1 EP-LUX IP 55

Typ	Kolor	Opak.	Waga	Indeks
		szt.	kg/100 szt.	
PK-1	biały RAL 9003	6	17,60	0250-00
	szary RAL 7035*	6	17,60	0250-04

NORMA: PN-IEC-60998-1:2006.
Wymiary wewnętrzne: 125x125x21 mm
Wymiary: 135x135x62 mm

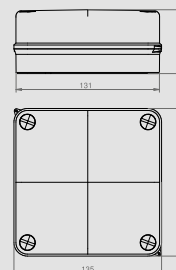

IP 20 650 °C 400 V PP

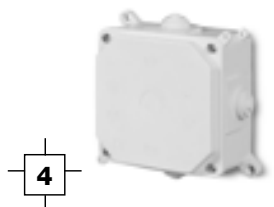

PUSZKA N/T PK-2 IP 20

Typ	Kolor	Opak.	Waga	Indeks
		szt.	kg/100 szt.	
PK-2 IP 20	biały RAL 9003	6	15,50	0215-00

NORMA: PN-IEC-60998-1:2006. Ilość wejść: 4 – dławnice.
Wymiary wewnętrzne: 85x85x46 mm
Wymiary: 101x101x59 mm

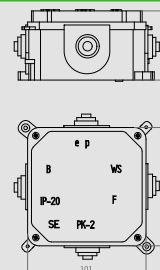

IP 55 650 °C 400 V PP

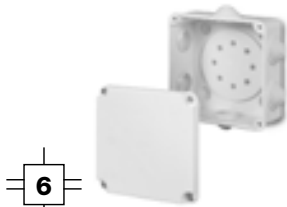

PUSZKA N/T HERMETYCZNA PK-2 EP-LUX IP 55

Typ	Kolor	Opak.	Waga	Indeks
		szt.	kg/100 szt.	
PK-2	biały RAL 9003	8	11,90	0222-00
	szary RAL 7035*	8	11,90	0222-04

NORMA: PN-IEC-60998-1:2006. Ilość wejść: 6 – dławnic.
Wymiary wewnętrzne: 95x95x49 mm
Wymiary: 108x108x58 mm

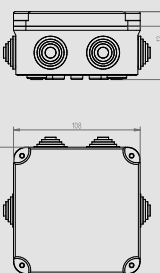

IP 55 650 °C 400 V PP

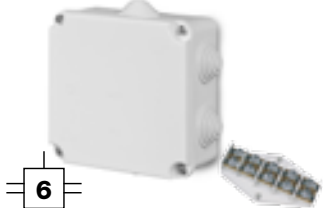

PUSZKA N/T HERMETYCZNA PK-2 EP-LUX Z WKŁADEM 5X4MM² IP 55

Typ	Kolor	Opak.	Waga	Indeks
		szt.	kg/100 szt.	
PK-2	biały RAL 9003	8	16,00	0221-00
	szary RAL 7035*	8	16,00	0221-04

NORMA: PN-IEC-60998-1:2006. Ilość wejść: 6 – dławnic.
Wymiary wewnętrzne: 95x95x49 mm
Wymiary: 108x108x58 mm
Z wkładem 5x4 mm²

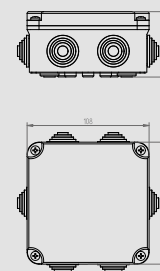

* - na zamówienie indywidualne

IP 55 650 °C 400 V PP



PUSZKA N/T HERMETYCZNA PK-3 EP-LUX IP 55

Typ	Kolor	Opak.	Waga	Indeks
		szt.	kg/100 szt.	
PK-3	biały RAL 9003	9	13,80	0251-00
	szary RAL 7035*	9	13,80	0251-04

NORMA: PN-IEC-60998-1:2006.
Wymiary wewnętrzne: 125x125x21 mm
Wymiary: 135x135x58 mm

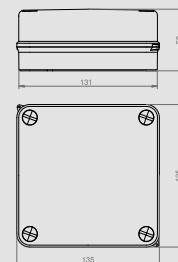

IP 20 650 °C 400 V PP



PUSZKA N/T PK-4 IP 20

Typ	Kolor	Opak.	Waga	Indeks
		szt.	kg/100 szt.	
PK-4 IP20	biały RAL 9003	6	19,3	0217-00

NORMA: PN-IEC-60998-1:2006. Ilość wejść: 4 – dławnice.
Wymiary wewnętrzne: 126x126x46 mm
Wymiary: 134x134x50 mm

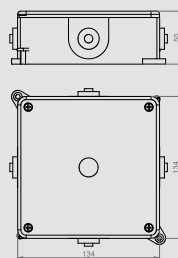

IP 55 650 °C 400 V PP



PUSZKA N/T HERMETYCZNA PK-4 EP-LUX IP 55

Typ	Kolor	Opak.	Waga	Indeks
		szt.	kg/100 szt.	
PK-4	biały RAL 9003	6	21,60	0233-00
	szary RAL 7035*	6	21,60	0233-14

NORMA: PN-IEC-60998-1:2006. Ilość wejść: 6 – dławnic.
Wymiary wewnętrzne: 125x125x42 mm
Wymiary: 133x133x64 mm

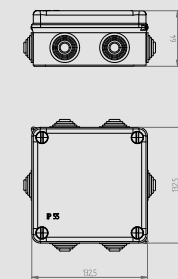

IP 55 650 °C 400 V PP



PUSZKA N/T HERMETYCZNA PK-4 EP-LUX Z WKŁADEM 5X10MM² IP 55

Typ	Kolor	Opak.	Waga	Indeks
		szt.	kg/100 szt.	
PK-4	biały RAL 9003	6	31,00	0233-01
	szary RAL 7035*	6	31,00	0233-14

NORMA: PN-IEC-60998-1:2006. Ilość wejść: 6 – dławnic.
Wymiary wewnętrzne: 125x125x42 mm
Wymiary: 133x133x64 mm
Z wkładem 5x10 mm²

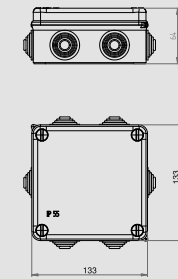

IP 55 650 °C 400 V PP



PUSZKA N/T HERMETYCZNA PK-4 EP-LUX Z WKŁADEM 5X16MM² IP 55

Typ	Kolor	Opak.	Waga	Indeks
		szt.	kg/100 szt.	
PK-4	biały RAL 9003	6	36,60	0233-02
	szary RAL 7035*	6	36,60	0233-24

NORMA: PN-IEC-60998-1:2006. Ilość wejść: 6 – dławnic.
Wymiary wewnętrzne: 125x125x42 mm
Wymiary: 133x133x64 mm
Z wkładem 5x16 mm²

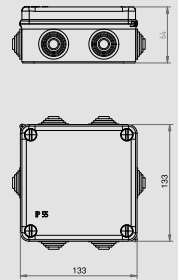

IP 55 650 °C 400 V PP



PUSZKA N/T HERMETYCZNA PK-5 EP-LUX IP 55

Typ	Kolor	Opak.	Waga	Indeks
		szt.	kg/100 szt.	
PK-5	biały RAL 9003	6	24,30	0252-00
	szary RAL 7035*	6	24,30	0252-04

NORMA: PN-IEC-60998-1:2006. Ilość wejść: 6 – dławnic.
Wymiary wewnętrzne: 125x125x42 mm
Wymiary: 133x133x83 mm

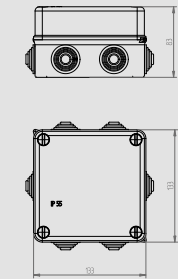

* - na zamówienie indywidualne

IP 55 650 °C 400 V PP

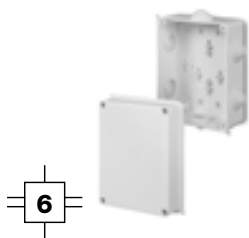

PUSZKA N/T HERMETYCZNA PK-6 EP-LUX IP 55

Typ	Kolor	Opak.	Waga	Indeks
		szt.	kg/100 szt.	
PK-6	biały RAL 9003	6	22,56	0227-00
	szary RAL 7035*	6	22,56	0227-04

NORMA: PN-IEC-60998-1:2006. Ilość wejść: 6 – dławnic.
Wymiary wewnętrzne: 108x147x86 mm
Wymiary: 158x118x94 mm

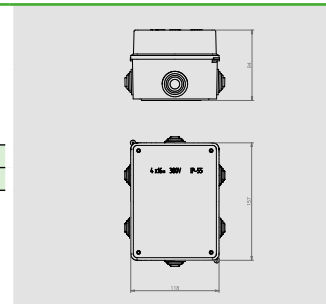

IP 55 650 °C 400 V PP

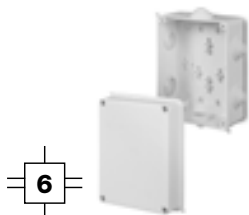

PUSZKA N/T HERMETYCZNA PK-6 EP-LUX 158X118X80 IP 55

Typ	Kolor	Opak.	Waga	Indeks
		szt.	kg/100 szt.	
PK-6	biały RAL 9003	6	21,85	0227-10
	szary RAL 7035*	6	21,85	0227-14

NORMA: PN-IEC-60998-1:2006. Ilość wejść: 6 – dławnic.
Wymiary wewnętrzne: 108x147x86 mm
Wymiary: 157x118x94 mm

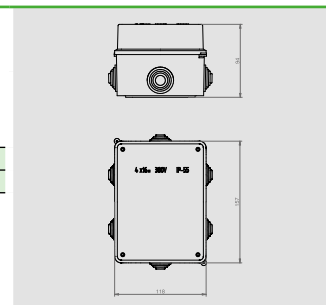

IP 55 650 °C 400 V PP

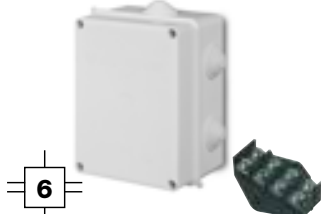

PUSZKA N/T HERMETYCZNA PK-6 EP-LUX Z WKŁADEM 4X16 MM² IP 55

Typ	Kolor	Opak.	Waga	Indeks
		szt.	kg/100 szt.	
PK-6	biały RAL 9003	6	36,20	0228-00
	szary RAL 7035*	6	36,20	0228-04

NORMA: PN-IEC-60998-1:2006. Ilość wejść: 6 – dławnic.
Wymiary wewnętrzne: 108x147x86 mm
Wymiary: 157x118x94 mm
Z wkładem 4x16 mm²

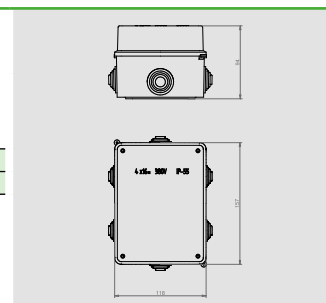

IP 55 650 °C 400 V PP

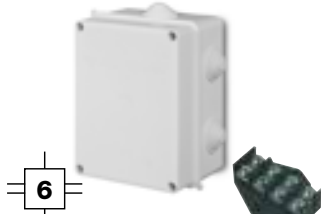

PUSZKA N/T HERMETYCZNA PK-6 EP-LUX 158X118X80 Z WKŁADEM 4X16 MM² NISKA IP 55

Typ	Kolor	Opak.	Waga	Indeks
		szt.	kg/100 szt.	
PK-6	biały RAL 9003	6	32,90	0228-10
	szary RAL 7035*	6	32,90	0228-14

NORMA: PN-IEC-60998-1:2006. Ilość wejść: 6 – dławnic.
Wymiary wewnętrzne: 108x147x86 mm
Wymiary: 157x118x80 mm
Z wkładem 4x16 mm²

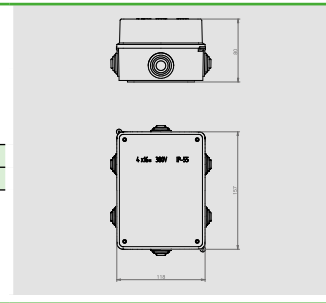

IP 55 650 °C 400 V PP

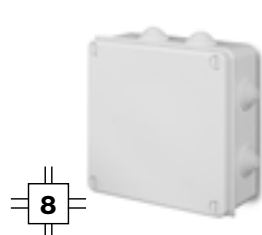

PUSZKA N/T HERMETYCZNA PK-7 EP-LUX IP 55

Typ	Kolor	Opak.	Waga	Indeks
		szt.	kg/100 szt.	
PK-7	biały RAL 9003	3	28,00	0238-01
	szary RAL 7035*	3	28,00	0238-14

NORMA: PN-IEC-60998-1:2006. Ilość wejść: 8 – dławnic.
Wymiary wewnętrzne: 163x163x55 mm
Wymiary: 172x172x75 mm

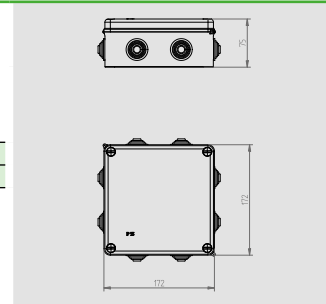

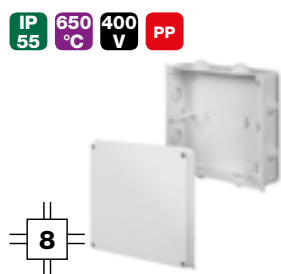

PUSZKA N/T HERMETYCZNA PK-8 EP-LUX IP 55

Typ	Kolor	Opak.	Waga	Indeks
		szt.	kg/100 szt.	
PK-8	biały RAL 9003	1	39,35	0231-00
	szary RAL 7035*	1	39,35	0231-04

NORMA: PN-IEC-60998-1:2006.
Ilość wejść: 8-dławnic
Wymiary wewnętrzne: 188x188x53 mm
Wymiary: 196x196x78 mm

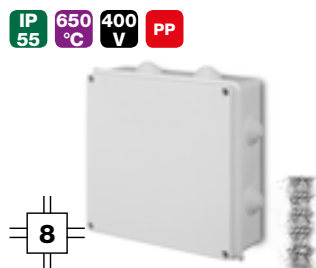
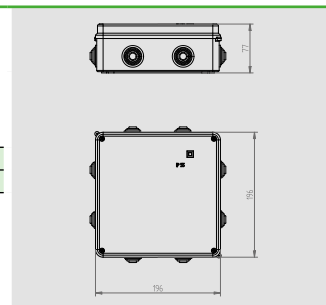

PUSZKA N/T HERMETYCZNA PK-8 EP-LUX Z WKŁADEM 5X35 MM² IP 55

Typ	Kolor	Opak.	Waga	Indeks
		szt.	kg/100 szt.	
PK-8	biały RAL 9003	1	70,16	0232-00
	szary RAL 7035*	1	70,16	0232-04

NORMA: PN-IEC-60998-1:2006.
Ilość wejść: 8-dławnic
Z wkładem 5x35 mm²
Wymiary wewnętrzne: 188x188x53 mm
Wymiary: 196x196x78 mm

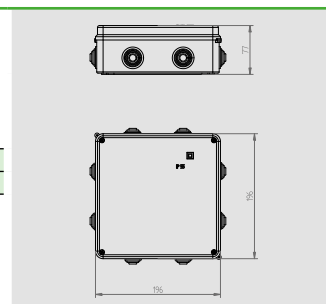

PUSZKA N/T HERMETYCZNA PK-9 EP-LUX Z DŁAWICAMI IP 55

Typ	Kolor	Opak.	Waga	Indeks
		szt.	kg/100 szt.	
PK-9	szary RAL 7035*	1	77,00	0253-00

NORMA: PN-IEC-60998-1:2006.
Ilość wejść: 8-dławnic
Wymiary wewnętrzne: 287x200x112 mm
Wymiary: 303x214x123 mm

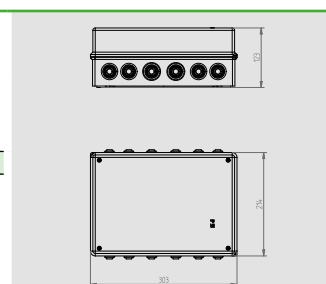

PUSZKA N/T HERMETYCZNA PK-9 EP-LUX BEZ DŁAWIC IP 55

Typ	Kolor	Opak.	Waga	Indeks
		szt.	kg/100 szt.	
PK-9	szary RAL 7035*	1	80,00	0253-30

NORMA: PN-IEC-60998-1:2006.
Wymiary wewnętrzne: 287x200x112 mm
Wymiary: 303x214x123 mm

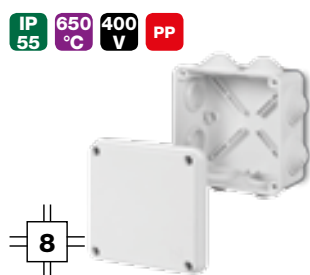
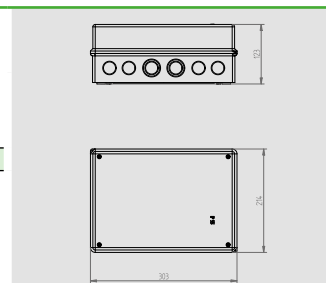

PUSZKA N/T HERMETYCZNA EP-LUX 100X100X52 IP 55

Typ	Kolor	Opak.	Waga	Indeks
		szt.	kg/100 szt.	
IP55	biały RAL 9003	15	13,52	0243-10

NORMA: PN-IEC-60998-1:2006.
Wymiary wewnętrzne: 100x100x52 mm
Wymiary: 110x110x67 mm

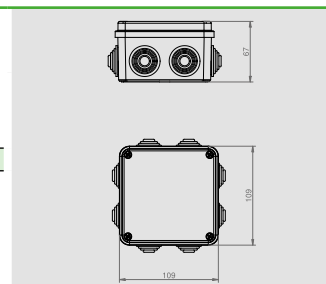

PUSZKA N/T HERMETYCZNA EP-LUX 110X80X40 IP 55

Typ	Kolor	Opak.	Waga	Indeks
		szt.	kg/100 szt.	
IP 55	biały RAL 9003	20	15,50	0244-00

NORMA: PN-IEC-60998-1:2006.
Wymiary wewnętrzne: 110x80x40 mm
Wymiary: 118x87x55 mm

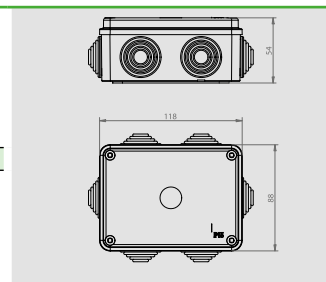

* - na zamówienie indywidualne

IP 55 IP 65 650 °C 400 V PP TPE



PUSZKA 2K 98X98X46 IP55/IP65 (PUSTA)

Typ	Kolor	Opak.	Waga	Indeks
		szt.	kg/100 szt.	
Odgałęźna 2K	Biały RAL 9003	8	8,80	0290-00
	Szary RAL 7035	8	8,80	0290-04
	Brąz RAL 8028	8	8,80	0290-06

NORMA: DIN EN 60670-22 IEC 60670-22
Z zewnętrznymi uchwytami do montażu, membrany elastyczne Ø20
Wymiary wewnętrzne: 88x88x38 mm Wymiary: 98x98x46 mm

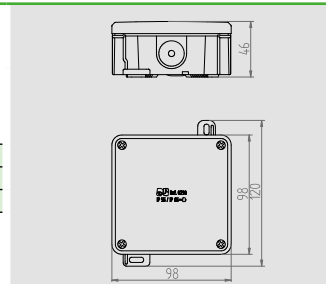

IP 55 IP 65 650 °C 400 V PP TPE



PUSZKA 2K 98X98X46 5X2,5MM² IP55/IP65 (Z ZACISKAMI)

Typ	Kolor	Opak.	Waga	Indeks
		szt.	kg/100 szt.	
Odgałęźna 2K	Biały RAL 9003	8	8,95	0290-01
	Szary RAL 7035	8	8,95	0290-41
	Brąz RAL 8028	8	8,95	0290-61

NORMA: DIN EN 60670-22 IEC 60670-22
Z zewnętrznymi uchwytami do montażu, membrany elastyczne Ø20
W komplecie: zaciski 5x2,5mm² Wymiary wewnętrzne: 88x88x38 mm
Wymiary: 98x98x46 mm

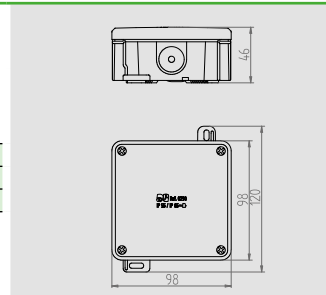

IP 55 IP 65 650 °C 400 V PP TPE



PUSZKA 2K 98X98X46 5X2,5 - MM², 4XPG 13,5MM IP55/IP65 (ZACISKI+DŁAWIKI GWINTOWANE)

Typ	Kolor	Opak.	Waga	Indeks
		szt.	kg/100 szt.	
4xPG 13,5 mm IP68	Szary RAL 7035	8	8,80	0290-80
4xPG 13,5 mm IP68 / 5x2,5 mm	Szary RAL 7035	8	8,80	0290-81

NORMA: DIN EN 60670-22 IEC 60670-22
Z zewnętrznymi uchwytami do montażu, membrany elastyczne Ø20
W komplecie: zaciski 5x2,5mm², dławiki gwintowane PG 13,5mm IP68
Wymiary wewnętrzne: 88x88x38 mm
Wymiary: 98x98x46 mm

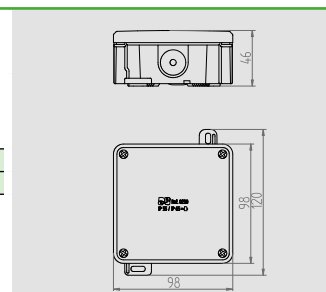

kolorowe zaciski montażowe 2,5 mm² w celu uporządkowania instalacji i ułatwiający montaż

uszy montażowe do montażu w korytach za pomocą opasek zaciskowych

elastyczne membrany 2K do wprowadzania przewodów

elastyczne membrany 2K przystosowane do dławic PG 13,5 mm IP68

dławice PG 13,5 mm IP68

IP 55 IK 07 400 V



E10 PUSZKA HERMETYCZNA N/T 45X90 IP55

Typ	Kolor	Opak.	Waga	Indeks
		szt.	kg/100 szt.	
E10	szary RAL 7035	20	2,0	0295-00

Puszka łączeniowa posiada 10 wpustów do montażu w kanałach kablowych
 NORMA: DIN EN 60670
 Wymiary: 45x90x39 mm

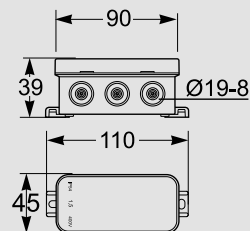

IP 55 IK 07 400 V



E7 PUSZKA HERMETYCZNA N/T 75X75 IP55

Typ	Kolor	Opak.	Waga	Indeks
		szt.	kg/100 szt.	
E7	szary RAL 7035	20	4,0	0296-00

Puszka łączeniowa posiada 6 wpustów do montażu w kanałach kablowych
 NORMA: DIN EN 60670
 Wymiary: 75x75x39 mm

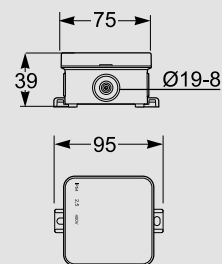

IP 55 IK 07 400 V



E12 PUSZKA HERMETYCZNA N/T 85X85 IP55

Typ	Kolor	Opak.	Waga	Indeks
		szt.	kg/100 szt.	
E12	szary RAL 7035	20	4,5	0297-00

Puszka łączeniowa posiada 12 wpustów do montażu w kanałach kablowych
 NORMA: DIN EN 60670
 Wymiary: 85x85x39 mm

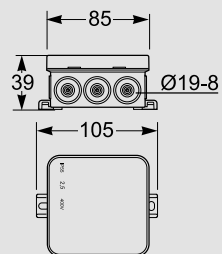

IP 41 650 °C 250 V PS



PUSZKA IP 41 60X60X30

Typ	Kolor	Opak.	Waga	Indeks
		szt.	kg/100 szt.	
IP 41	biały RAL 9003 czarny RAL 9005*	30	2,60	0236-00 0236-02

NORMA: PN-IEC-60998-1:2006.
Puszka do zastosowań teleinformatycznych.
Wymiary wewnętrzne: 55x55x25 mm
Wymiary: 60x60x30 mm

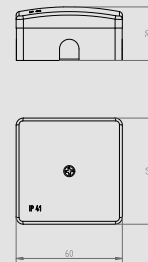

IP 20 650 °C 400 V PP



PUSZKA N/T EP-LUX Z WKŁADEM 5X2.5 MM² IP 20

Typ	Kolor	Opak.	Waga	Indeks
		szt.	kg/100 szt.	
n/t EP-LUX IP 20	biały RAL 9003	20	6,20	0225-00

NORMA: PN-IEC-60998-1:2006.
Wymiary wewnętrzne: 85x74x13 mm
Wymiary: 89x79x25 mm

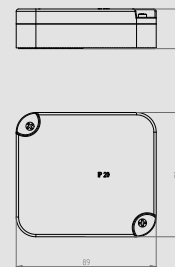

IP 41 650 °C 400 V PP



PUSZKA HERMETYCZNA N/T PUSTA P0 IP 41

Typ	Kolor	Opak.	Waga	Indeks
		szt.	kg/100 szt.	
P0	biały RAL 9003	20	5,00	0211-00

NORMA: PN-IEC-60998-1:2006.
Wymiary wewnętrzne: 73x25 mm
Wymiary: Ø 73x głęb. 28 mm

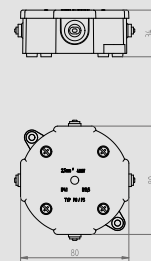

IP 41 650 °C 400 V PP



PUSZKA HERMETYCZNA N/T Z WKŁADEM 4X2,5 MM² IP41

Typ	Kolor	Opak.	Waga	Indeks
		szt.	kg/100 szt.	
P5	biały RAL 9003	20	6,80	0212-00

NORMA: PN-IEC-60998-1:2006.
Wymiary wewnętrzne: 65x29 mm
Wymiary: Ø 73x głęb. 28 mm

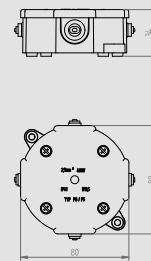

IP 42 650 °C 400 V PP



PUSZKA HERMETYCZNA N/T PUSTA IP 42

Typ	Kolor	Opak.	Waga	Indeks
		szt.	kg/100 szt.	
380	biały RAL 9003	20	5,50	0214-00

NORMA: PN-IEC-60998-1:2006.
Wymiary wewnętrzne: 67x67x30 mm
Wymiary: 86x86x35 mm

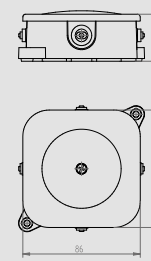

IP 42 650 °C 400 V PP



PUSZKA HERMETYCZNA N/T Z WKŁADEM 4X2,5 MM² IP 42

Typ	Kolor	Opak.	Waga	Indeks
		szt.	kg/100 szt.	
380	biały RAL 9003	20	7,20	0213-00

NORMA: PN-IEC-60998-1:2006.
Wymiary wewnętrzne: 67x67x30 mm
Wymiary: 86x86x35 mm

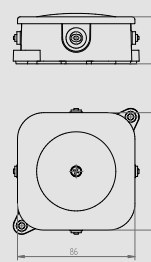

IP 55 650 °C 400 V PP

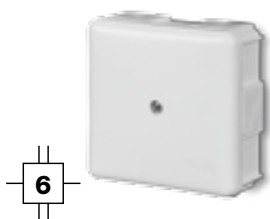

PUSZKA 6-WYL.N/T EP-LUX 5X2.5 MM² PUSTY IP 55

Typ	Kolor	Opak.	Waga	Indeks
		szt.	kg/100 szt.	
EP-LUX IP55	biały RAL 9003	20	6,90	0226-00

NORMA: PN-IEC-60998-1:2006.
Wymiary wewnętrzne: 78x78x32 mm
Wymiary: 86x86x39 mm

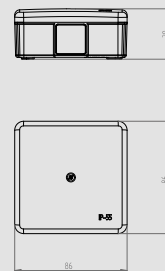

IP 55 650 °C 400 V PP



PUSZKA 6-WYL.N/T EP-LUX 5X2.5 MM² PUSTY IP 55

Typ	Kolor	Opak.	Waga	Indeks
		szt.	kg/100 szt.	
EP-LUX IP55	czarny RAL 9005*	20	6,90	0226-02
	brązowy RAL 8028*			0226-60
	szary RAL 7035*			0226-04

NORMA: PN-IEC-60998-1:2006.
Wymiary wewnętrzne: 78x78x32 mm
Wymiary: 86x86x39 mm

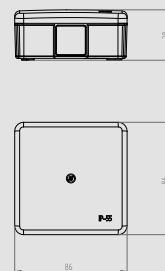

IP 55 650 °C 400 V PP

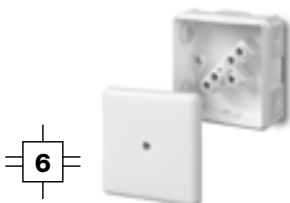

PUSZKA 6-WYL.N/T EP-LUX 5X2.5 MM² Z WKŁADEM IP 55

Typ	Kolor	Opak.	Waga	Indeks
		szt.	kg/100 szt.	
EP-LUX IP55	biały RAL 9003	20	9,10	0226-01
	szary RAL 7035			0226-05

NORMA: PN-IEC-60998-1:2006.
Wymiary wewnętrzne: 78x78x32 mm
Wymiary: 86x86x39 mm

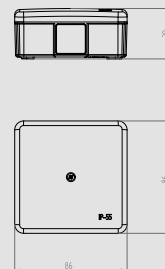

IP 55 650 °C 400 V PP

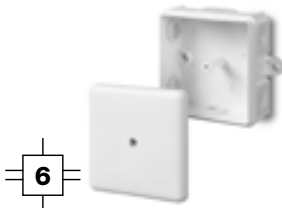

PUSZKA 6-WYL.N/T MZ EP-LUX 5X2.5 MM² PUSTY IP 55

Typ	Kolor	Opak.	Waga	Indeks
		szt.	kg/100 szt.	
EP-LUX IP55	biały RAL 9003	20	6,90	0226-10

NORMA: PN-IEC-60998-1:2006.
Z zewnętrznymi uchwytami do montażu.
Wymiary wewnętrzne: 78x78x32 mm
Wymiary: 86x86x39 mm

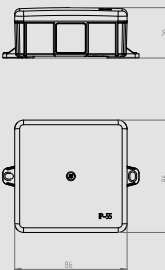

IP 55 650 °C 400 V PP

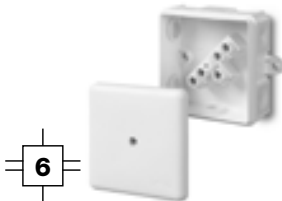

PUSZKA 6-WYL.N/T MZ EP-LUX 5X2.5 MM² Z WKŁADEM IP 55

Typ	Kolor	Opak.	Waga	Indeks
		szt.	kg/100 szt.	
EP-LUX IP55	biały RAL 9003	20	9,10	0226-11
	szary RAL 7035	20	9,10	0226-41

NORMA: PN-IEC-60998-1:2006.
Z zewnętrznymi uchwytami do montażu.
Wymiary wewnętrzne: 78x78x32 mm
Wymiary: 86x86x39 mm

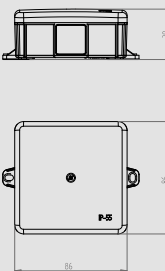

IP 55 650 °C 400 V PP



PUSZKA 6-WYL.N/T MZ EP-LUX 5X2.5 MM² Z WKŁADEM IP 55

Typ	Kolor	Opak.	Waga	Indeks
		szt.	kg/100 szt.	
EP-LUX IP55	brązowy RAL 8028	20	9,10	0226-61

NORMA: PN-IEC-60998-1:2006.
Z zewnętrznymi uchwytami do montażu.
Wymiary wewnętrzne: 78x78x32 mm
Wymiary: 86x86x39 mm

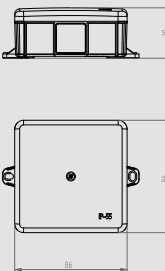

* - na zamówienie indywidualne

IP 55 650 °C 400 V ABS PC



CARBO-BOX OBUDOWA 158X118X80 IP55

Typ	Kolor	Opak.	Waga	Indeks
CARBO-BOX IP55	szary RAL 7035	1 szt.	26,00 kg/100 szt.	0229-00

NORMA: PN-IEC-60998-1:2006.
Wymiary wewnętrzne: 109x149x54 mm
Wymiary: 157x118x94 mm

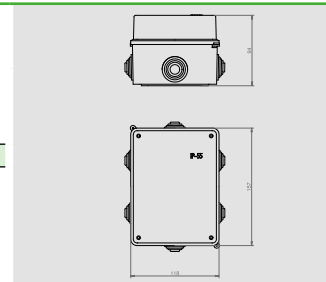

IP 55 650 °C 400 V ABS PC



CARBO-BOX OBUDOWA 158X118X80 IP55 Z SZYNA

Typ	Kolor	Opak.	Waga	Indeks
CARBO-BOX IP55	szary RAL 7035	1 szt.	30,00 kg/100 szt.	0230-00

NORMA: PN-IEC-60998-1:2006.
Szyrna TH 35
Wymiary wewnętrzne: 109x149x54 mm
Wymiary: 118x157x94 mm

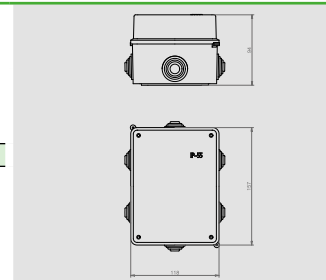

IP 55 650 °C 400 V ABS PC



CARBO-BOX OBUDOWA 303X213X125 IP55

Typ	Kolor	Opak.	Waga	Indeks
CARBO-BOX IP55	szary RAL 7035	1 szt.	80,00 kg/100 szt.	0253-20

NORMA: PN-IEC-60998-1:2006.
Wymiary: 303x214x123 mm

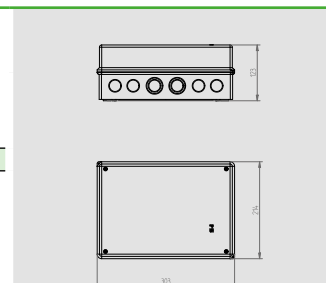

IP 55 650 °C 400 V ABS PC



CARBO-BOX OBUDOWA 303X213X125 IP55 Z SZYNA

Typ	Kolor	Opak.	Waga	Indeks
CARBO-BOX IP55	szary RAL 7035	1 szt.	80,00 kg/100 szt.	0253-10

NORMA: PN-IEC-60998-1:2006.
Szyrna TH 35
Wymiary wewnętrzne: 109x149x54 mm
Wymiary: 303x214x123 mm

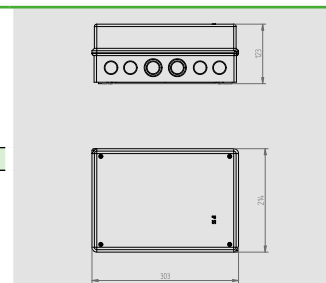



PRZEMYSŁOWA JAKOŚĆ



- Stopień ochrony IP65
- Wytrzymałość na uderzenia IK07
- Opcja plombowania obudowy
- Kolor obudowy szary RAL 7035
- Zwiększona odporność obudowy na promieniowanie UV
- Metalowe wkręty mocujące
- Elastyczna uszczelka
- Rysunki CAD do pobrania na stronie www
- Uszczelnienie obudowy
- Bezhalogenowe
- Dostępność w wielu rozmiarach

WYMIARY

Puszki hermetyczne INDUSTRIAL IP65

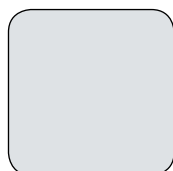
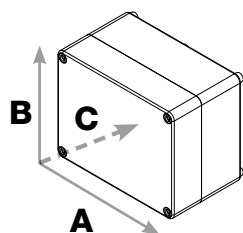

105 x 105

wymiar A/B/C	indeks
105x105x66	2701-00
105x105x140	2702-00

105x105x66	2701-01
------------	---------

-00 pokrywa kolor szary RAL7035
-01 pokrywa transparentna



110 x 75

wymiar A/B/C	indeks
110x75x59	2703-00
110x75x90	2704-00

110x75x59	2703-01
-----------	---------

-00 pokrywa kolor szary RAL7035
-01 pokrywa transparentna

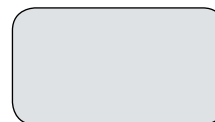

135 x 74

wymiar A/B/C	indeks
135x74x72	2705-00
135x74x105	2706-00

135x74x72	2705-01
-----------	---------

-00 pokrywa kolor szary RAL7035
-01 pokrywa transparentna

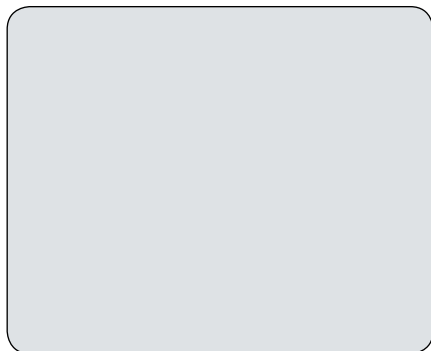

270 x 220

wymiar A/B/C	indeks
270x220x106	2719-00
270x220x126	2720-00
270x220x168	2721-00

270x220x106	2719-01
270x220x126	2720-01
270x220x168	2721-01

-00 pokrywa kolor szary RAL7035
-01 pokrywa transparentna

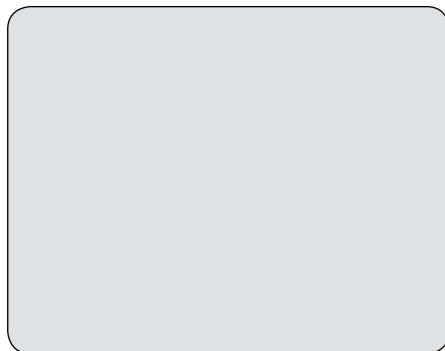

280 x 220

wymiar A/B/C	indeks
280x220x127	2722-00

-00 pokrywa kolor szary RAL7035

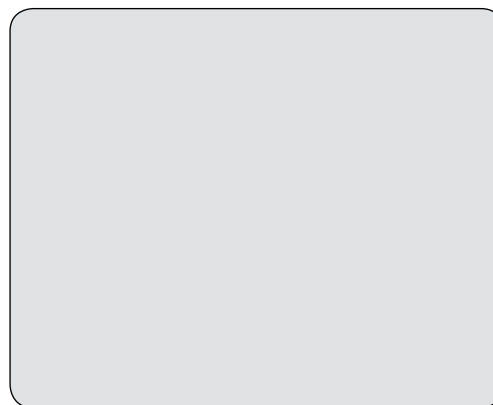

313 x 253

wymiar A/B/C	indeks
313x253x115	2723-00
313x253x165	2724-00

313x253x115	2723-01
313x253x165	2724-01

-00 pokrywa kolor szary RAL7035
-01 pokrywa transparentna

WYMIARY

Puszki hermetyczne INDUSTRIAL IP65

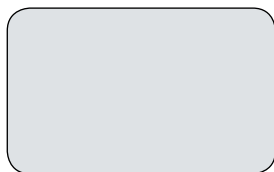
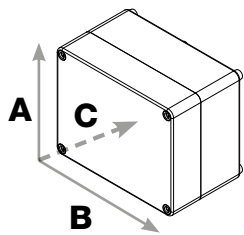

170 x 105

wymiar A/B/C	indeks
170x105x82	2707-00
170x105x112x	2708-00

170x105x82	2707-01
------------	---------

-00 pokrywa kolor szary RAL7035
-01 pokrywa transparentna

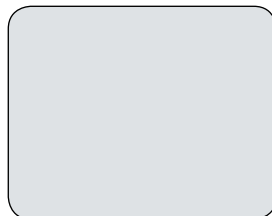

170 x 135

wymiar A/B/C	indeks
170 x 135x147	2709-00
170x135x241	2710-00
170x135x85	2711-00
170x135x107	2712-00
170x135x145	2713-00
170x135x176	2714-00
170x135x177	2715-00

170x135x241	2710-01
170x135x85	2711-01
170x135x107	2712-01
170x135x177	2715-01

-00 pokrywa kolor szary RAL7035
-01 pokrywa transparentna

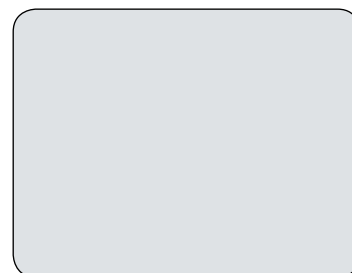

220 x 170

wymiar A/B/C	indeks
220x170x86	2716-00
220x170x107	2717-00
220x170x146	2718-00

220x170x86	2716-01
220x170x107	2717-01
220x170x146	2718-01

-00 pokrywa kolor szary RAL7035
-01 pokrywa transparentna

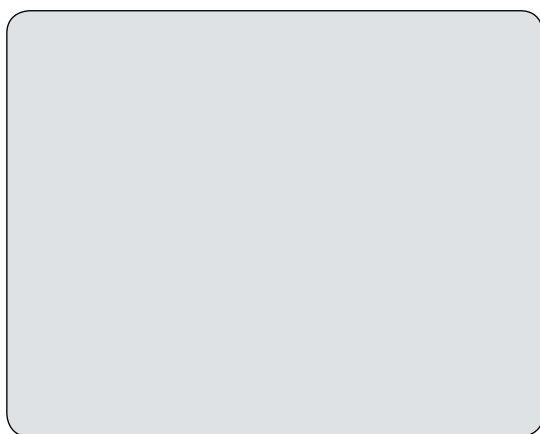

340 x 270

wymiar A/B/C	indeks
340x270x106	2725-00
340x270x165	2726-00

340x270x106	2725-01
340x270x165	2726-01

-00 pokrywa kolor szary RAL7035
-01 pokrywa transparentna

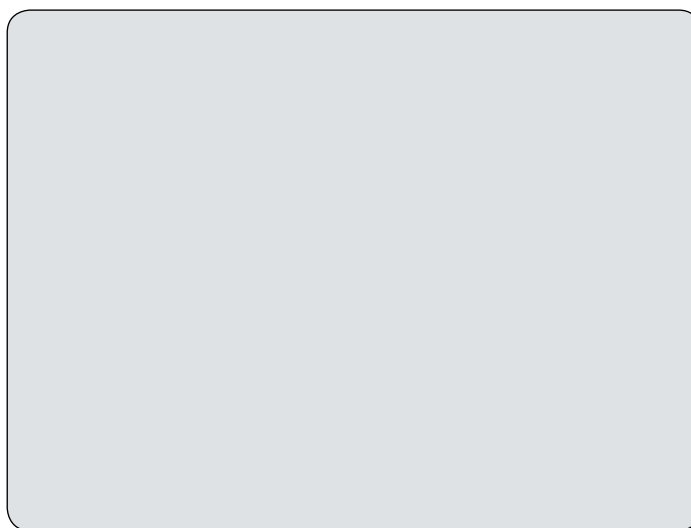

440 x 330

wymiar A/B/C	indeks
440x330x145	2727-00

440x330x145	2727-01
-------------	---------

-00 pokrywa kolor szary RAL7035
-01 pokrywa transparentna

WYMIARY

Puszki hermetyczne INDUSTRIAL IP65

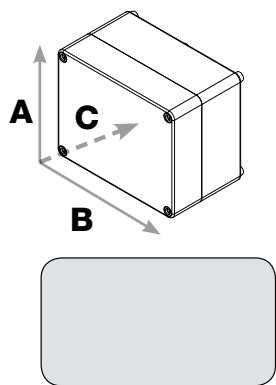

180x330

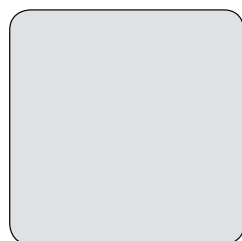

330x330

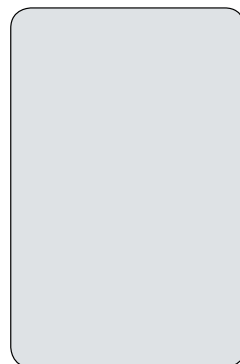

506x330

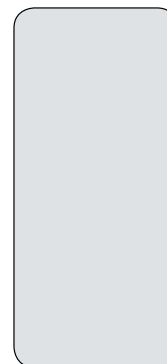

506x230

wymiar A/B/C	indeks
180x330x130	2749-00

wymiar A/B/C	indeks
330x330x130	2750-00

wymiar A/B/C	indeks
506x330x13	2751-00

wymiar A/B/C	indeks
130x95x58	2752-00



Pokrywa transparentna
indeks z końcówką: X X X X- **01**



Pokrywa w kolorze obudowy szary RAL 7035
indeks z końcówką: X X X X- **00**

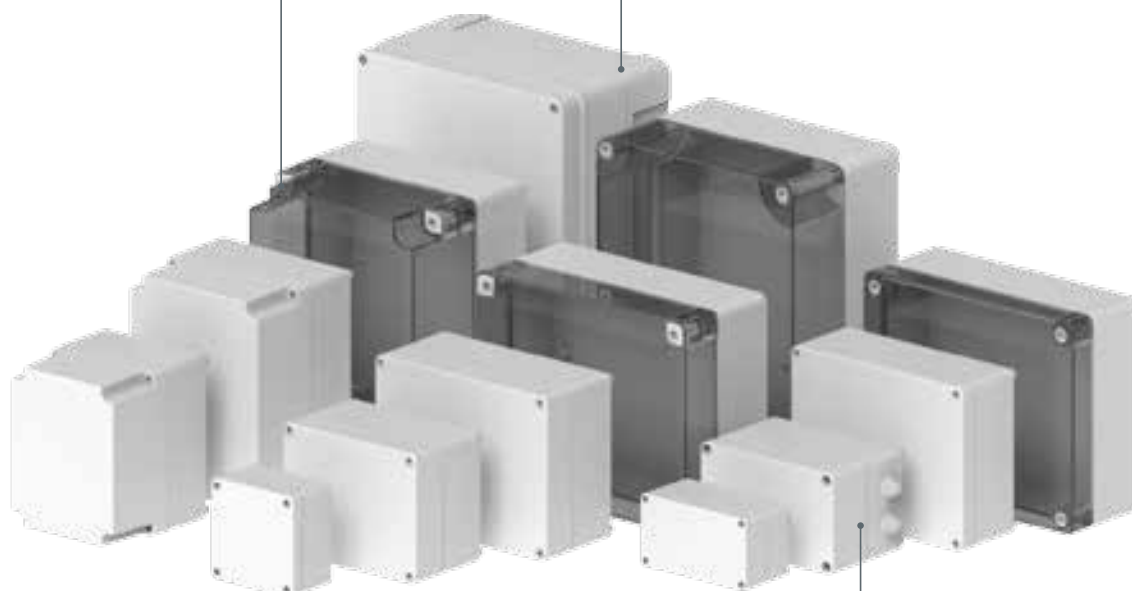

Puszki z dźwigniami
z pokrywą w kolorze obudowy szary RAL 7035
indeks z końcówką: X X X X- **02**

WYMIARY

Puszki hermetyczne INDUSTRIAL IP55 z dławicami

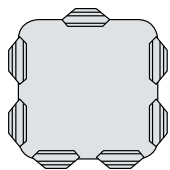

102 x 102

wymiar A/B/C	indeks
102x102x47	2700-02

-02 szary RAL 7035

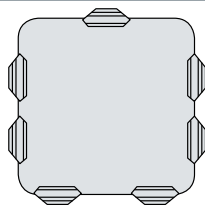

129 x 129

wymiar A/B/C	indeks
129x129x61	2701-02

-02 szary RAL 7035

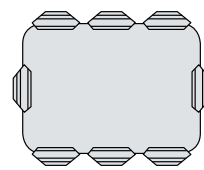

130 x 95

wymiar A/B/C	indeks
130x95x58	2703-02

-02 szary RAL 7035

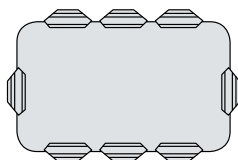

156 x 95

wymiar A/B/C	indeks
156x95x68	2705-02

-02 szary RAL 7035

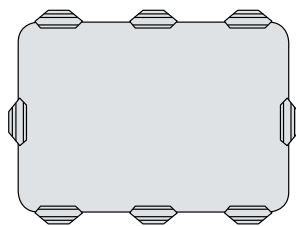

198 x 95

wymiar A/B/C	indeks
198x139x82	2705-02

-02 szary RAL 7035

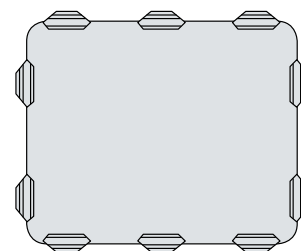

198 x 163

wymiar A/B/C	indeks
198x163x80	2711-02

-02 szary RAL 7035

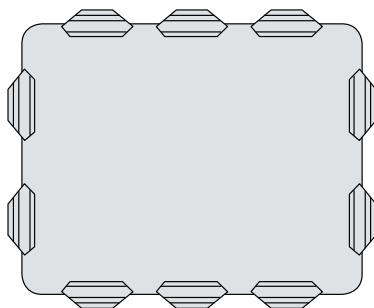

249 x 198

wymiar A/B/C	indeks
249x198x81	2716-02

-02 szary RAL 7035

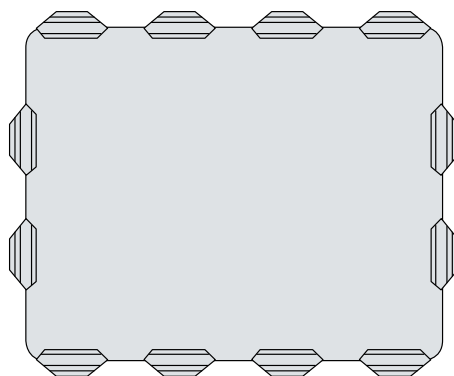

305 x 244

wymiar A/B/C	indeks
305x244x126	2721-02
305x244x168	2722-02

-02 szary RAL 7035

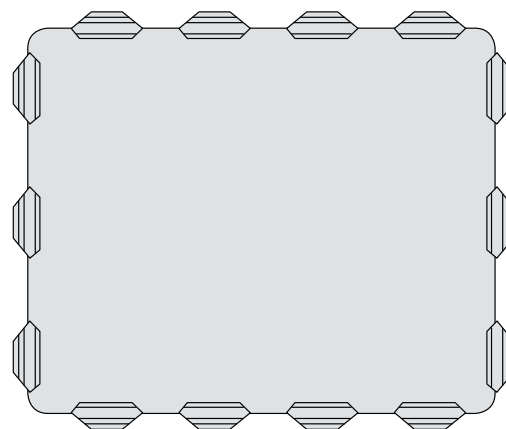

342 x 282

wymiar A/B/C	indeks
342x282x115	2723-02
342x282x165	2724-02

-02 szary RAL 7035



INDUSTRIAL PUSZKA N/T 105X105X66 IP65

Typ	Kolor	Opak.	Waga	Indeks
Industrial IP65	szary RAL 7035	szt. 1	kg/1szt. 0,26	2701-00

NORMA PN-EN-60670-1
Wymiary wewnętrzne: 99x99x56
Wymiary zewnętrzne: 105x105x66

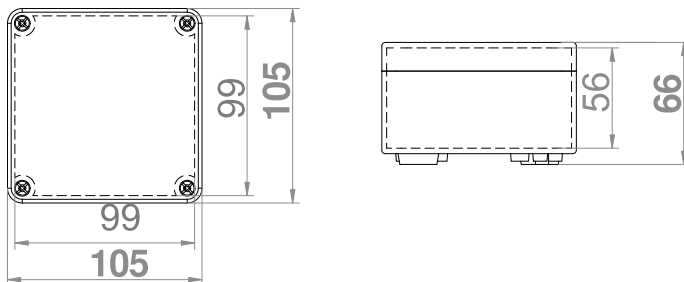

INDUSTRIAL PUSZKA N/T 105X105X140 IP65

Typ	Kolor	Opak.	Waga	Indeks
Industrial IP65	szary RAL 7035	szt. 1	kg/1szt. 0,25	2702-00

NORMA PN-EN-60670-1
Wymiary wewnętrzne: 99x99x131
Wymiary zewnętrzne: 105x105x140

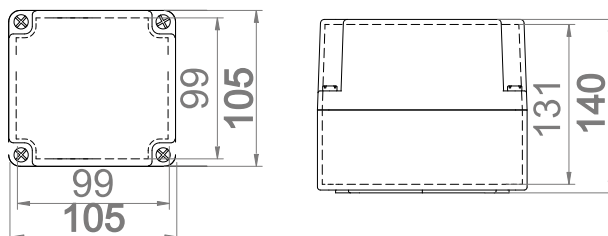

INDUSTRIAL PUSZKA N/T 110X75X59 IP65

Typ	Kolor	Opak.	Waga	Indeks
Industrial IP65	szary RAL 7035	szt. 5	kg/1szt. 0,15	2703-00

NORMA PN-EN-60670-1
Wymiary wewnętrzne: 105x70x46
Wymiary zewnętrzne: 110x75x59

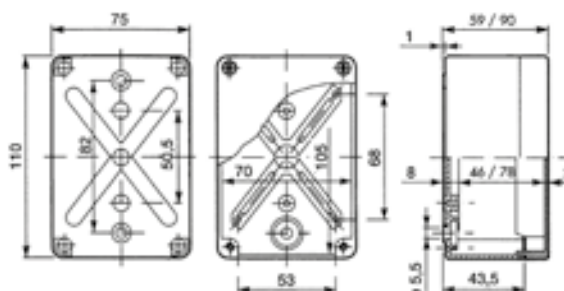

IP 65 IK 07 400 V Br Cl



INDUSTRIAL PUSZKA N/T 110X75X90 IP65

Typ	Kolor	Opak.	Waga	Indeks
Industrial IP65	szary RAL 7035	szt.	kg/1szt.	
		1	0,24	2704-00

NORMA PN-EN-60670-1
Wymiary wewnętrzne: 105x70x78
Wymiary zewnętrzne: 110x75x90

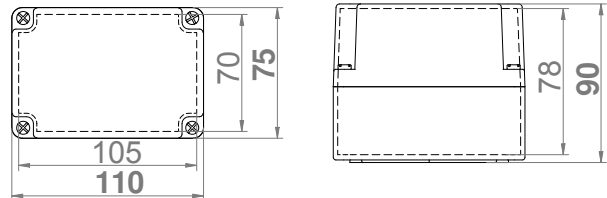

IP 65 IK 07 400 V Br Cl



INDUSTRIAL PUSZKA N/T 135X74X72 IP65

Typ	Kolor	Opak.	Waga	Indeks
Industrial IP65	szary RAL 7035	szt.	kg/1szt.	
		1	0,22	2705-00

NORMA PN-EN-60670-1
Wymiary wewnętrzne: 130x69x57
Wymiary zewnętrzne: 135x74x72

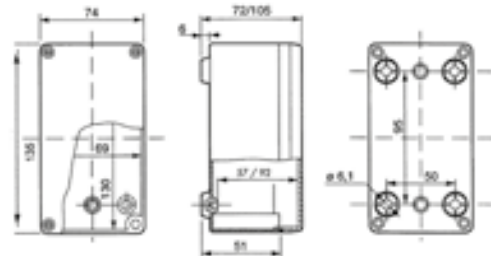

IP 65 IK 07 400 V Br Cl



INDUSTRIAL PUSZKA N/T 135X74X105 IP65

Typ	Kolor	Opak.	Waga	Indeks
Industrial IP65	szary RAL 7035	szt.	kg/1szt.	
		1	0,22	2706-00

NORMA PN-EN-60670-1
Wymiary wewnętrzne: 130x69x92
Wymiary zewnętrzne: 135x74x105

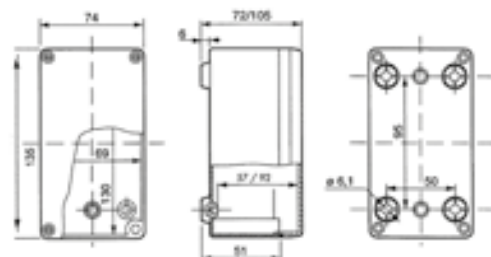

IP 65 IK 07 400 V Br Cl



INDUSTRIAL PUSZKA N/T 170X105X82 IP65

Typ	Kolor	Opak.	Waga	Indeks
Industrial IP65	szary RAL 7035	szt. 1	kg/1szt. 0,46	2707-00

NORMA PN-EN-60670-1
Wymiary wewnętrzne: 164x99x67
Wymiary zewnętrzne: 170x105x82

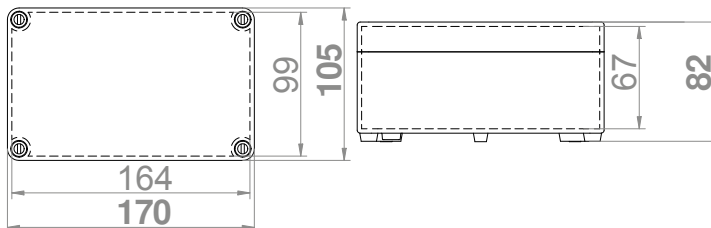

IP 65 IK 07 400 V Br Cl



INDUSTRIAL PUSZKA N/T 170X105X112 IP65

Typ	Kolor	Opak.	Waga	Indeks
Industrial IP65	szary RAL 7035	szt. 1	kg/1szt. 0,61	2708-00

NORMA PN-EN-60670-1
Wymiary wewnętrzne: 164x99x97
Wymiary zewnętrzne: 170x105x112

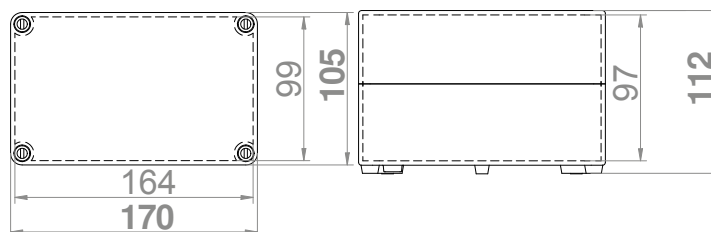

IP 65 IK 07 400 V Br Cl



INDUSTRIAL PUSZKA N/T 170X135X147 IP65

Typ	Kolor	Opak.	Waga	Indeks
Industrial IP65	szary RAL 7035	szt. 1	kg/1szt. 0,60	2709-00

NORMA PN-EN-60670-1
Wymiary wewnętrzne: 164x129x132
Wymiary zewnętrzne: 170x135x147

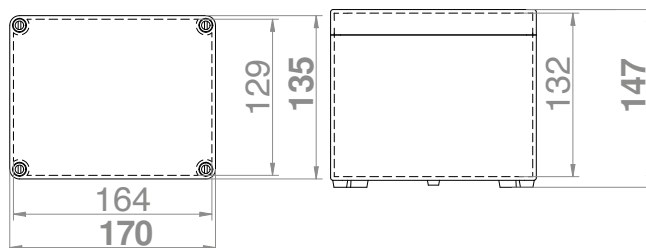

IP 65 IK 07 400 V Br Cl



INDUSTRIAL PUSZKA N/T 170X135X241 IP65

Typ	Kolor	Opak.	Waga	Indeks
Industrial IP65	szary RAL 7035	szt. 1	kg/1szt. 0,63	2710-00

NORMA PN-EN-60670-1
Wymiary wewnętrzne: 164x129x225
Wymiary zewnętrzne: 170x135x241

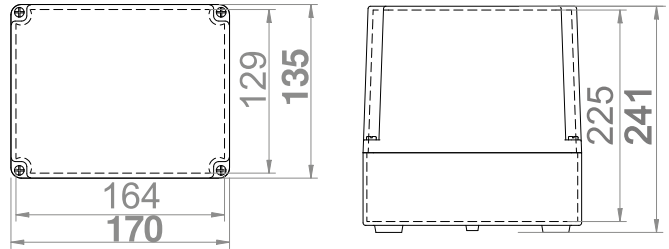

IP 65 IK 07 400 V Br Cl 2K



INDUSTRIAL PUSZKA N/T 170X135X85 IP65

Typ	Kolor	Opak.	Waga	Indeks
Industrial IP65	szary RAL 7035	szt. 1	kg/1szt. 0,49	2711-00

NORMA PN-EN-60670-1
Wymiary wewnętrzne: 164x129x70
Wymiary zewnętrzne: 170x135x85

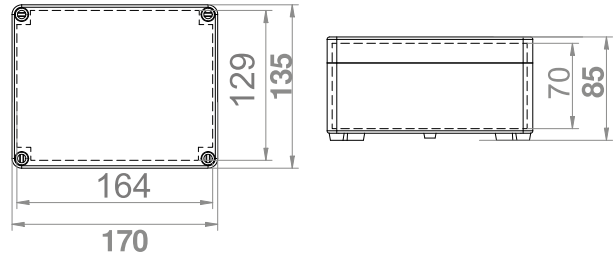

IP 65 IK 07 400 V Br Cl



INDUSTRIAL PUSZKA N/T 170X135X107 IP65

Typ	Kolor	Opak.	Waga	Indeks
Industrial IP65	szary RAL 7035	szt. 1	kg/1szt. 0,50	2712-00

NORMA PN-EN-60670-1
Wymiary wewnętrzne: 164x129x91
Wymiary zewnętrzne: 170x135x107

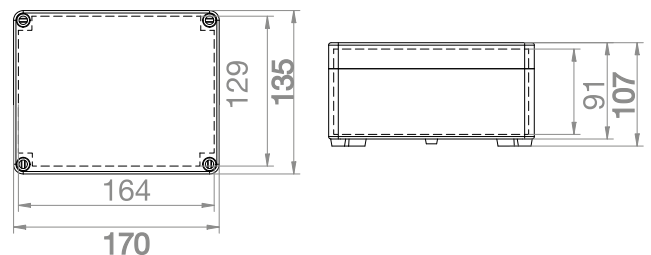



INDUSTRIAL PUSZKA N/T 170X135X145 IP65

Typ	Kolor	Opak.	Waga	Indeks
Industrial IP65	szary RAL 7035	szt. 1	kg/1szt. 0,69	2713-00

NORMA PN-EN-60670-1
 Wymiary wewnętrzne: 164x129x130
 Wymiary zewnętrzne: 170x135x145

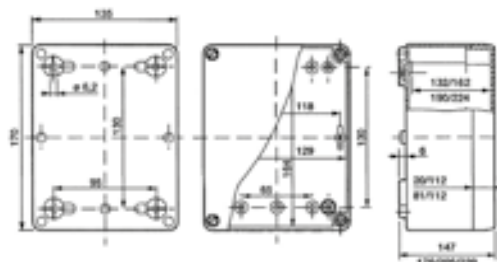

INDUSTRIAL PUSZKA N/T 170X135X176 IP65

Typ	Kolor	Opak.	Waga	Indeks
Industrial IP65	szary RAL 7035	szt. 1	kg/1szt. 0,46	2714-00

NORMA PN-EN-60670-1
 Wymiary wewnętrzne: 164x129x162
 Wymiary zewnętrzne: 170x135x176

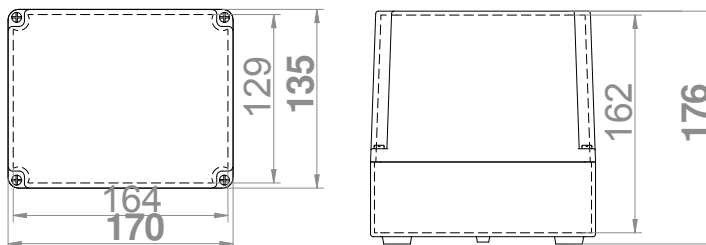

INDUSTRIAL PUSZKA N/T 170X135X176 IP65

Typ	Kolor	Opak.	Waga	Indeks
Industrial IP65	szary RAL 7035	szt. 1	kg/1szt. 0,46	2715-00

NORMA PN-EN-60670-1
 Wymiary wewnętrzne: 164x129x162
 Wymiary zewnętrzne: 170x135x176

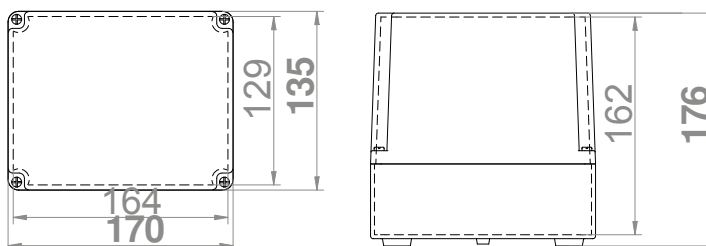

IP 65 IK 07 400 V Br Cl



INDUSTRIAL PUSZKA N/T 220X170X86 IP65

Typ	Kolor	Opak.	Waga	Indeks
		szt.	kg/1szt.	
Industrial IP65	szary RAL 7035	1	0,75	2716-00

NORMA PN-EN-60670-1
 Wymiary wewnętrzne: 214x164x69
 Wymiary zewnętrzne: 220x170x86

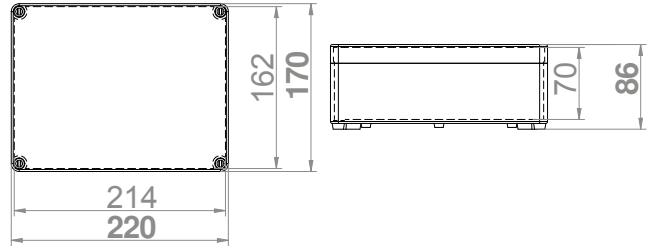

IP 65 IK 07 400 V Br Cl 2K



INDUSTRIAL PUSZKA N/T 220X170X107 IP65

Typ	Kolor	Opak.	Waga	Indeks
		szt.	kg/1szt.	
Industrial IP65	szary RAL 7035	1	0,86	2717-00

NORMA PN-EN-60670-1
 Wymiary wewnętrzne: 214x164x91
 Wymiary zewnętrzne: 220x170x107

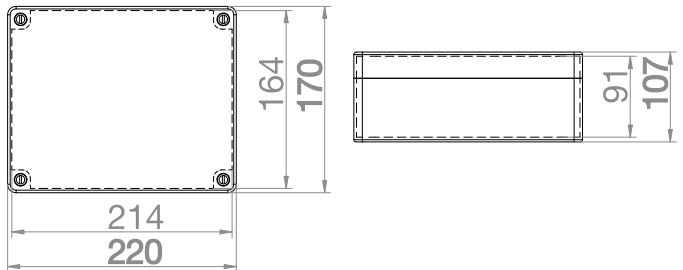

IP 65 IK 07 400 V Br Cl



INDUSTRIAL PUSZKA N/T 220X170X146 IP65

Typ	Kolor	Opak.	Waga	Indeks
		szt.	kg/1szt.	
Industrial IP65	szary RAL 7035	1	1,00	2718-00

NORMA PN-EN-60670-1
 Wymiary wewnętrzne: 214x162x130
 Wymiary zewnętrzne: 220x170x146

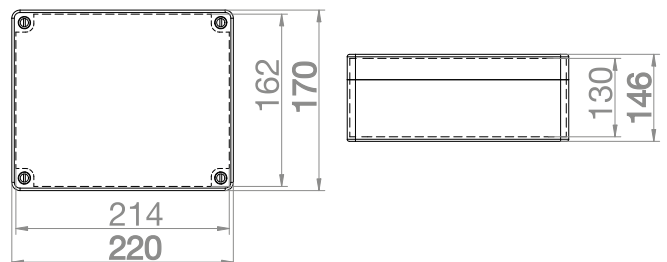



INDUSTRIAL PUSZKA N/T 270X220X106 IP65

Typ	Kolor	Opak.	Waga	Indeks
Industrial IP65	szary RAL 7035	szt. 1	kg/1szt. 1,31	2719-00

NORMA PN-EN-60670-1
Wymiary wewnętrzne: 264x214x89
Wymiary zewnętrzne: 270x220x106

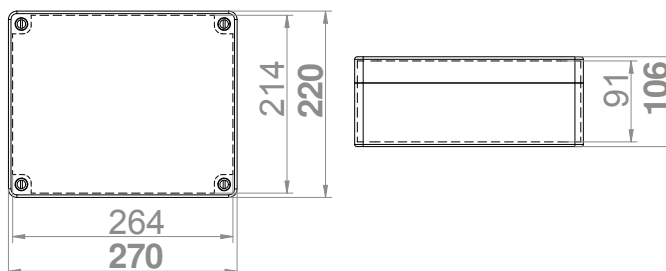

INDUSTRIAL PUSZKA N/T 270X220X126 IP65

Typ	Kolor	Opak.	Waga	Indeks
Industrial IP65	szary RAL 7035	szt. 1	kg/1szt. 1,35	2720-00

NORMA PN-EN-60670-1
Wymiary wewnętrzne: 264x214x109
Wymiary zewnętrzne: 270x220x126

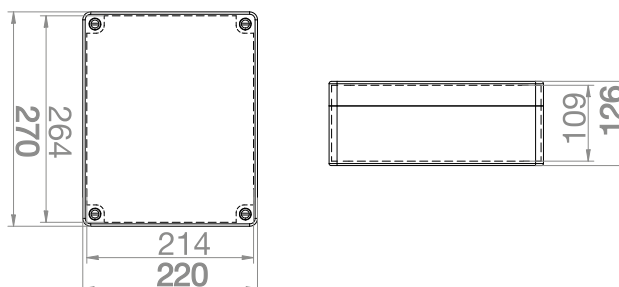

INDUSTRIAL PUSZKA N/T 270X220X168 IP65

Typ	Kolor	Opak.	Waga	Indeks
Industrial IP65	szary RAL 7035	szt. 1	kg/1szt. 1,49	2721-00

NORMA PN-EN-60670-1
Wymiary wewnętrzne: 264x214x151
Wymiary zewnętrzne: 270x220x168

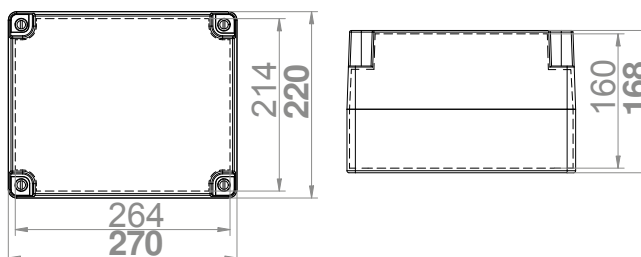



INDUSTRIAL PUSZKA N/T 280X220X174 IP65

Typ	Kolor	Opak.	Waga	Indeks
		szt.	kg/1szt.	
Industrial IP65	szary RAL 7035	1	1,30	2722-00

NORMA PN-EN-60670-1
 Wymiary wewnętrzne: 267x207x150
 Wymiary zewnętrzne: 280x220x174

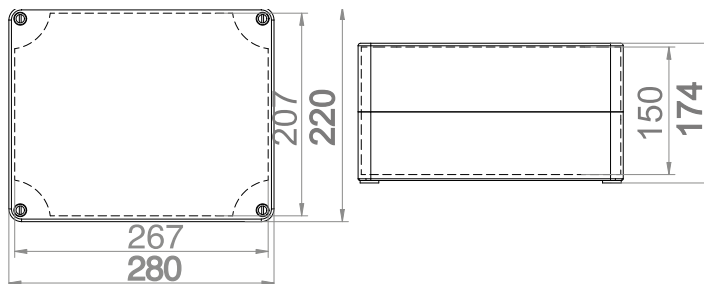

INDUSTRIAL PUSZKA N/T 313X253X115 IP65

Typ	Kolor	Opak.	Waga	Indeks
		szt.	kg/1szt.	
Industrial IP65	szary RAL 7035	1	1,64	2723-00

NORMA PN-EN-60670-1
 Wymiary wewnętrzne: 300x240x100
 Wymiary zewnętrzne: 313x253x115

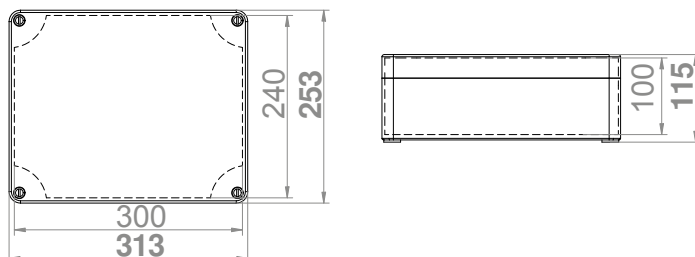

INDUSTRIAL PUSZKA N/T 313X253X165 IP65

Typ	Kolor	Opak.	Waga	Indeks
		szt.	kg/1szt.	
Industrial IP65	szary RAL 7035	1	2,30	2724-00

NORMA PN-EN-60670-1
 Wymiary wewnętrzne: 300x240x150
 Wymiary zewnętrzne: 313x253x165

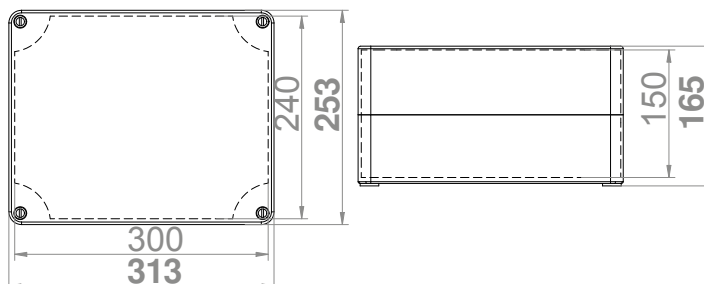

IP 65 IK 07 400 V Br Cl 2K



INDUSTRIAL PUSZKA N/T 340X270X106 IP65

Typ	Kolor	Opak.	Waga	Indeks
Industrial IP65	szary RAL 7035	szt. 1	kg/1szt. 2,00	2725-00

NORMA PN-EN-60670-1
Wymiary wewnętrzne: 328x258x91
Wymiary zewnętrzne: 340x270x106

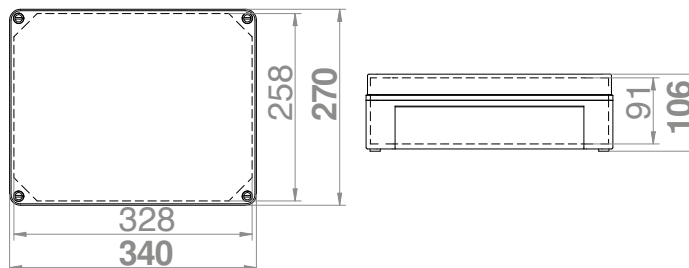

IP 65 IK 07 400 V Br Cl



INDUSTRIAL PUSZKA N/T 340X270X165 IP65

Typ	Kolor	Opak.	Waga	Indeks
Industrial IP65	szary RAL 7035	szt. 1	kg/1szt. 2,50	2726-00

NORMA PN-EN-60670-1
Wymiary wewnętrzne: 328x258x154
Wymiary zewnętrzne: 340x270x165

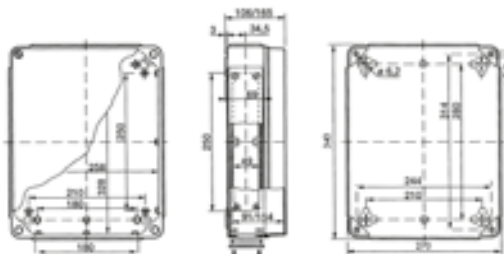

IP 65 IK 07 400 V Br Cl



INDUSTRIAL PUSZKA N/T 440X330X145 IP65

Typ	Kolor	Opak.	Waga	Indeks
Industrial IP65	szary RAL 7035	szt. 1	kg/1szt. 3,20	2727-00

NORMA PN-EN-60670-1
Wymiary wewnętrzne: 429x321x127
Wymiary zewnętrzne: 440x330x145
Wkręty tworzywowe ze sprężynami. Szybki montaż pokrywy -01.

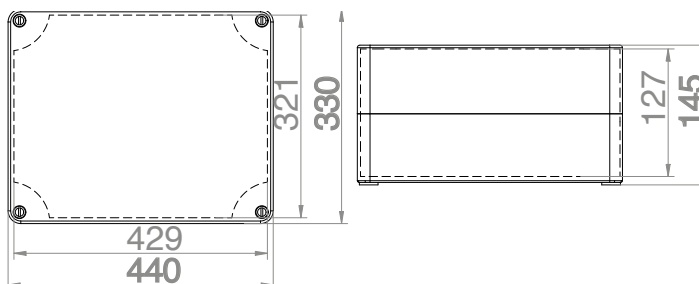

IP 65 650 °C Br Cl 400 V ABS



INDUSTRIAL PUSZKA N/T 180X330X130 IP65

Typ	Kolor	Opak. szt.	Waga kg/1 szt.	Stary Indeks	Indeks
Obudowa IP65	szary RAL 7035	1	1,06	0271-00	2749-00

NORMA: PN-IEC-60998-1:2006.
Wymiary: 188x330x132 mm

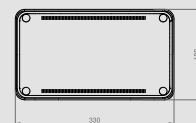

IP 65 650 °C Br Cl 400 V ABS



INDUSTRIAL PUSZKA N/T 330X330X130 IP65

Typ	Kolor	Opak. szt.	Waga kg/1szt.	Stary Indeks	Indeks
Obudowa IP65	szary RAL 7035	1	1,56	0272-00	2750-00

NORMA: PN-IEC-60998-1:2006.
Wymiary: 330x330x132 mm

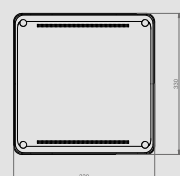

IP 65 650 °C Br Cl 400 V ABS



INDUSTRIAL PUSZKA N/T 506X330X130 IP65

Typ	Kolor	Opak. szt.	Waga kg/1 szt.	Stary Indeks	Indeks
Obudowa IP65	szary RAL 7035	1	2,18	0273-00	2751-00

NORMA: PN-IEC-60998-1:2006.
Wymiary: 514x330x132 mm

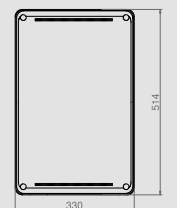

IP 65 650 °C Br Cl 400 V ABS



INDUSTRIAL PUSZKA N/T 506X230X130 IP65

Typ	Kolor	Opak. szt.	Waga kg/1 szt.	Stary Indeks	Indeks
Obudowa IP65	szary RAL 7035	1	1,85	0274-00	2752-00

NORMA: PN-IEC-60998-1:2006.
Wymiary: 506x230x130 mm

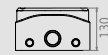

IP 65 IK 07 400 V PC



INDUSTRIAL PUSZKA N/T 105X105X66 IP65 PC

Typ	Kolor	Opak.	Waga	Indeks
Industrial IP65	szary RAL 7035	szt. 1	kg/1szt. 0,25	2701-01

NORMA PN-EN-60670-1
Wymiary wewnętrzne: 99x99x56
Wymiary zewnętrzne: 105x105x66

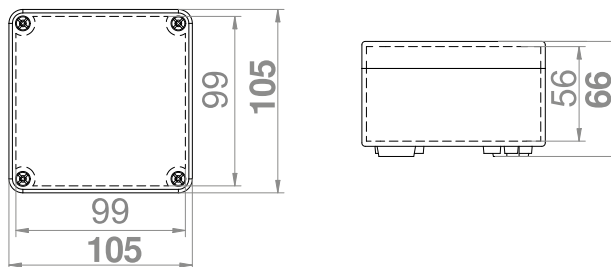

IP 65 IK 07 400 V PC



INDUSTRIAL PUSZKA N/T 110X75X59 IP65 PC

Typ	Kolor	Opak.	Waga	Indeks
Industrial IP65	szary RAL 7035	szt. 1	kg/1szt. 0,22	2703-01

NORMA PN-EN-60670-1
Wymiary wewnętrzne: 105x70x46
Wymiary zewnętrzne: 110x75x59

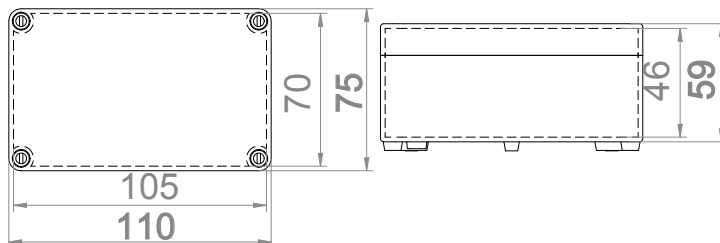

IP 65 IK 07 400 V PC



INDUSTRIAL PUSZKA N/T 170X135X177 IP65 PC

Typ	Kolor	Opak.	Waga	Indeks
Industrial IP65	szary RAL 7035	szt. 1	kg/1szt. -	2715-01

NORMA PN-EN-60670-1
Wymiary wewnętrzne: 164x129x160
Wymiary zewnętrzne: 170x135x177

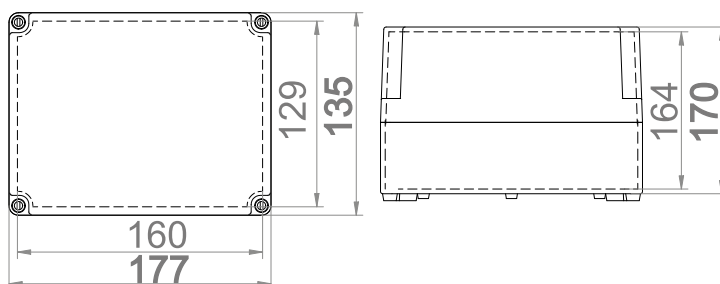

IP 65 IK 07 400 V PC



INDUSTRIAL PUSZKA N/T 135X74X72 IP65 PC

Typ	Kolor	Opak.	Waga	Indeks
Industrial IP65	szary RAL 7035	szt. 1	kg/1szt. 0,34	2705-01

NORMA PN-EN-60670-1
 Wymiary wewnętrzne: 130x69x57
 Wymiary zewnętrzne: 135x74x72

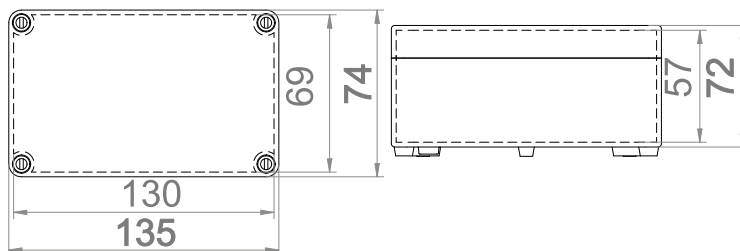

IP 65 IK 07 400 V PC



INDUSTRIAL PUSZKA N/T 170X105X82 IP65 PC

Typ	Kolor	Opak.	Waga	Indeks
Industrial IP65	szary RAL 7035	szt. 1	kg/1szt. 0,37	2707-01

NORMA PN-EN-60670-1
 Wymiary wewnętrzne: 164x99x67
 Wymiary zewnętrzne: 170x105x82

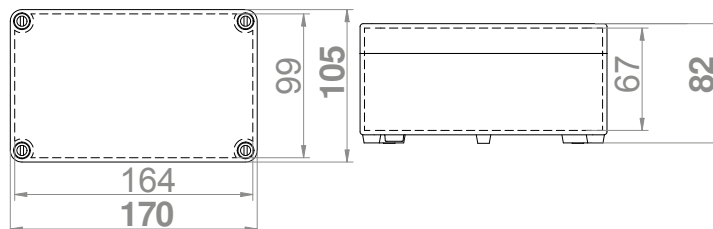

IP 65 IK 07 400 V PC



INDUSTRIAL PUSZKA N/T 170X135X85 IP65 PC

Typ	Kolor	Opak.	Waga	Indeks
Industrial IP65	szary RAL 7035	szt. 1	kg/1szt. 0,40	2711-01

NORMA PN-EN-60670-1
Wymiary wewnętrzne: 164x129x70
Wymiary zewnętrzne: 170x135x85

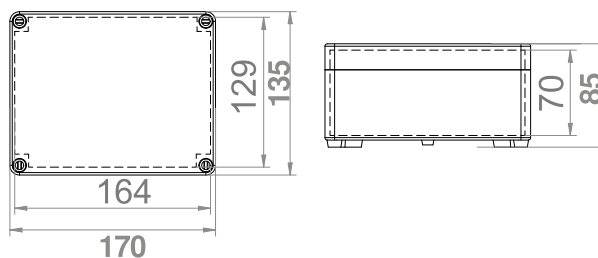

IP 65 IK 07 400 V PC



INDUSTRIAL PUSZKA N/T 170X135X107 IP65 PC

Typ	Kolor	Opak.	Waga	Indeks
Industrial IP65	szary RAL 7035	szt. 1	kg/1szt. 0,56	2712-01

NORMA PN-EN-60670-1
Wymiary wewnętrzne: 164x129x91
Wymiary zewnętrzne: 170x135x107

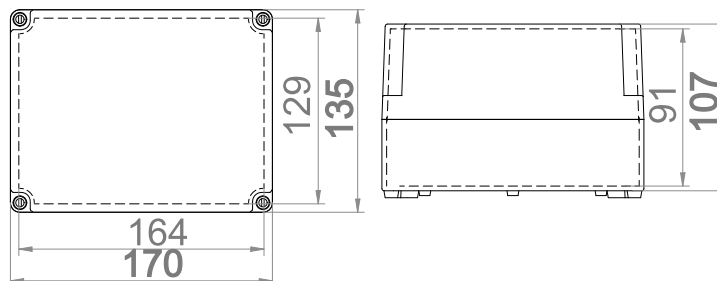

IP 65 IK 07 400 V PC



INDUSTRIAL PUSZKA N/T 220X170X86 IP65 PC

Typ	Kolor	Opak.	Waga	Indeks
Industrial IP65	szary RAL 7035	szt. 1	kg/1szt. 0,65	2716-01

NORMA PN-EN-60670-1
Wymiary wewnętrzne: 214x164x69
Wymiary zewnętrzne: 220x170x86

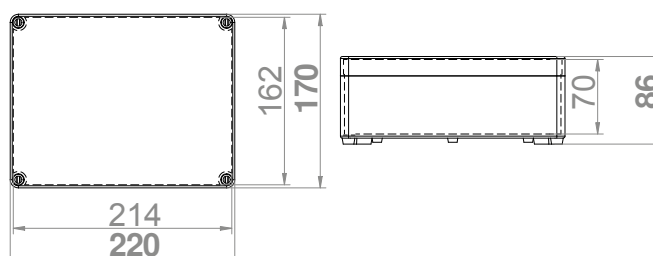

IP 65 IK 07 400 V PC



INDUSTRIAL PUSZKA N/T 220X170X107 IP65 PC

Typ	Kolor	Opak.	Waga	Indeks
Industrial IP65	szary RAL 7035	szt. 1	kg/1szt. 0,80	2717-01

NORMA PN-EN-60670-1
Wymiary wewnętrzne: 214x162x91
Wymiary zewnętrzne: 220x170x107

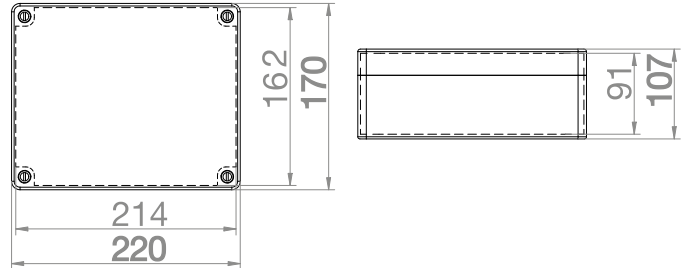

IP 65 IK 07 400 V PC



INDUSTRIAL PUSZKA N/T 220X170X146 IP65 PC

Typ	Kolor	Opak.	Waga	Indeks
Industrial IP65	szary RAL 7035	szt. 1	kg/1szt. 0,85	2718-01

NORMA PN-EN-60670-1
Wymiary wewnętrzne: 214x162x130
Wymiary zewnętrzne: 220x170x146

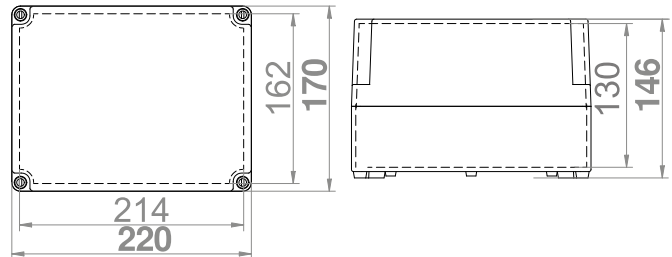

IP 65 IK 07 400 V PC



INDUSTRIAL PUSZKA N/T 270X220X106 IP65 PC

Typ	Kolor	Opak.	Waga	Indeks
Industrial IP65	szary RAL 7035	szt. 1	kg/1szt. 1,00	2719-01

NORMA PN-EN-60670-1
Wymiary wewnętrzne: 264x214x89
Wymiary zewnętrzne: 270x220x106

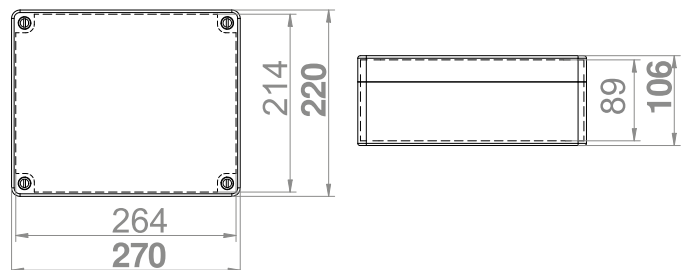

IP 65 IK 07 400 V PC



INDUSTRIAL PUSZKA N/T 270X220X126 IP65 PC

Typ	Kolor	Opak.	Waga	Indeks
Industrial IP65	szary RAL 7035	szt. 1	kg/1szt. 1,20	2720-01

NORMA PN-EN-60670-1
Wymiary wewnętrzne: 264x214x109
Wymiary zewnętrzne: 270x220x126

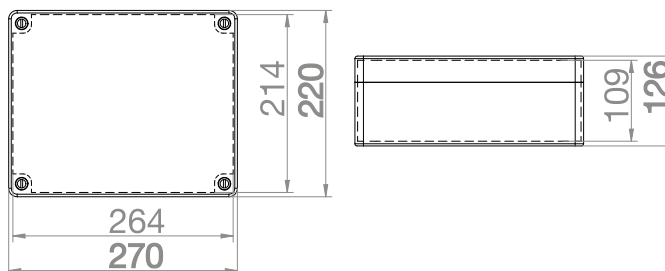

IP 65 IK 07 400 V PC



INDUSTRIAL PUSZKA N/T 270X220X168 IP65 PC

Typ	Kolor	Opak.	Waga	Indeks
Industrial IP65	szary RAL 7035	szt. 1	kg/1szt. 1,49	2721-01

NORMA PN-EN-60670-1
Wymiary wewnętrzne: 264x214x151
Wymiary zewnętrzne: 270x220x168

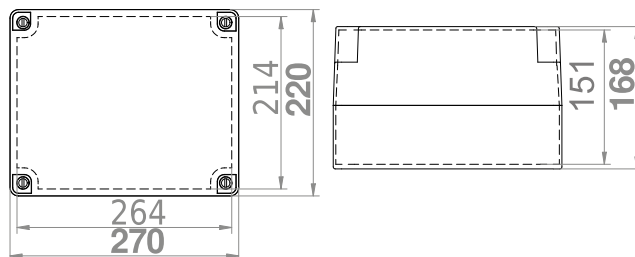

IP 65 IK 07 400 V PC



INDUSTRIAL PUSZKA N/T 313X253X115 IP65 PC

Typ	Kolor	Opak.	Waga	Indeks
Industrial IP65	szary RAL 7035	szt. 1	kg/1szt. 1,25	2723-01

NORMA PN-EN-60670-1
Wymiary wewnętrzne: 300x240x100
Wymiary zewnętrzne: 313x253x115

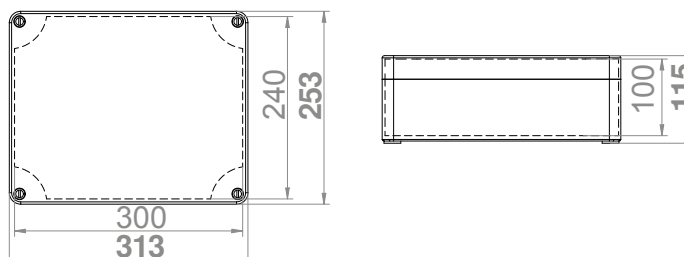

IP 65 IK 07 400 V PC



INDUSTRIAL PUSZKA N/T 313X253X165 IP65 PC

Typ	Kolor	Opak.	Waga	Indeks
Industrial IP65	szary RAL 7035	szk. szt.	kg/1szt.	
		1	1,85	2724-01

NORMA PN-EN-60670-1
 Wymiary wewnętrzne: 300x240x150
 Wymiary zewnętrzne: 313x253x165

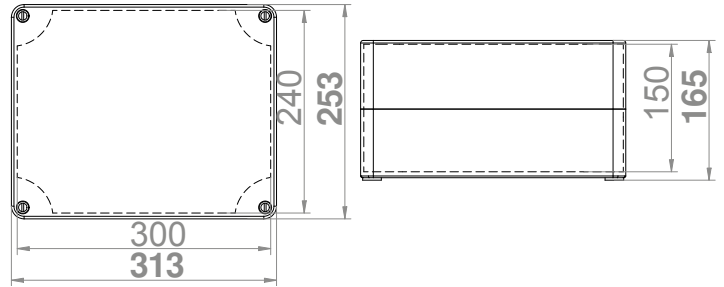

IP 65 IK 07 400 V PC



INDUSTRIAL PUSZKA N/T 340X270X106 PC

Typ	Kolor	Opak.	Waga	Indeks
Industrial IP65	szary RAL 7035	szk. szt.	kg/1szt.	
		1	1,45	2725-01

NORMA PN-EN-60670-1
 Wymiary wewnętrzne: 328x258x91
 Wymiary zewnętrzne: 340x270x106

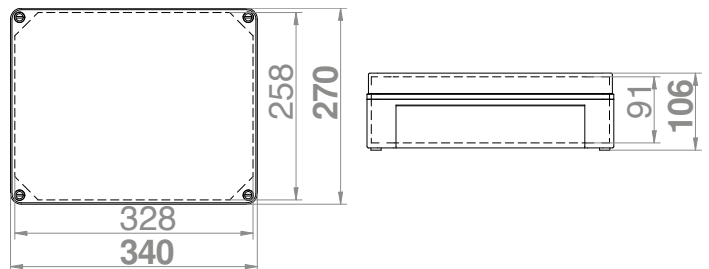

IP 65 IK 07 400 V PC



INDUSTRIAL PUSZKA N/T 340X270X165 IP65 PC

Typ	Kolor	Opak.	Waga	Indeks
Industrial IP65	szary RAL 7035	szk. szt.	kg/1szt.	
		1	-	2726-01

NORMA PN-EN-60670-1
 Wymiary wewnętrzne: 328x258x151
 Wymiary zewnętrzne: 340x270x165

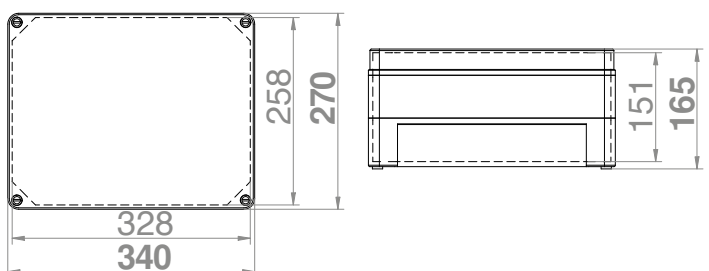

IP 65 IK 07 400 V PC



INDUSTRIAL PUSZKA N/T 440X330X145 IP65 PC

Typ	Kolor	Opak.	Waga	Indeks
		szt.	kg/1szt.	
Industrial IP65	szary RAL 7035	1	3,20	2727-01

NORMA PN-EN-60670-1
 Wymiary wewnętrzne: 429x321x127
 Wymiary zewnętrzne: 440x330x145

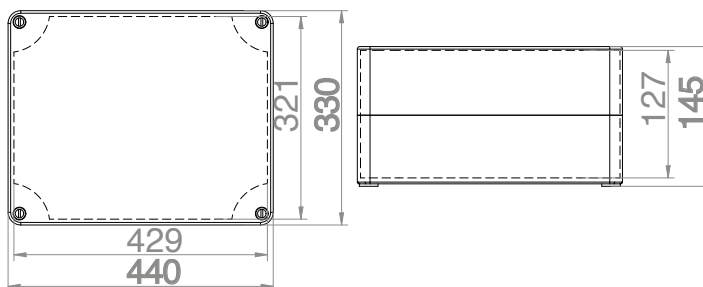

IP 55 IK 07 400 V Br Cl

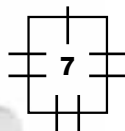

INDUSTRIAL PUSZKA N/T 102X102X47 Z 7 DŁAWICAMI

Typ	Kolor	Opak.	Waga	Indeks
Industrial IP55	szary RAL 7035	1 szt.	kg/1szt.	2700-02

NORMA PN-EN-60670-1
Wymiary wewnętrzne: 65x65x30
Wymiary zewnętrzne: 102x102x47

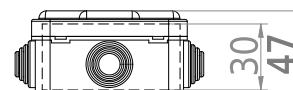
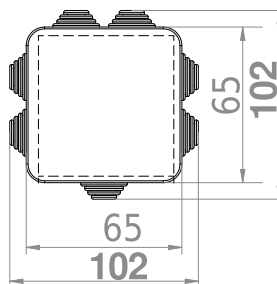

IP 55 IK 07 400 V Br Cl

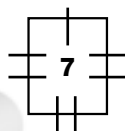

INDUSTRIAL PUSZKA N/T 129X129X61 Z 7 DŁAWICAMI

Typ	Kolor	Opak.	Waga	Indeks
Industrial IP55	szary RAL 7035	1 szt.	kg/1szt.	2728-02

NORMA PN-EN-60670-1
Wymiary wewnętrzne: 100x100x50
Wymiary zewnętrzne: 129x129x61

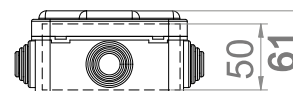
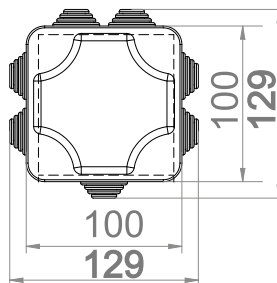

IP 55 IK 07 400 V Br Cl

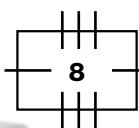

INDUSTRIAL PUSZKA N/T 130X95X58 Z 8 DŁAWICAMI

Typ	Kolor	Opak.	Waga	Indeks
Industrial IP55	szary RAL 7035	1 szt.	kg/1szt.	2703-02

NORMA PN-EN-60670-1
Wymiary wewnętrzne: 105x70x48
Wymiary zewnętrzne: 130x95x58

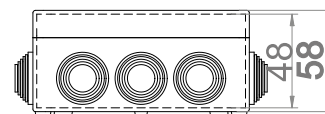
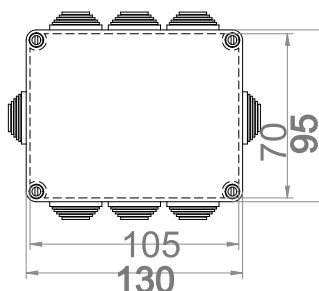

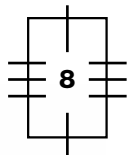

INDUSTRIAL PUSZKA N/T 156X95X68 Z 8 DŁAWICAMI

Typ	Kolor	Opak.	Waga	Indeks
Industrial IP55	szary RAL 7035	szt. 1	kg/1szt. -	2705-02

NORMA PN-EN-60670-1
Wymiary wewnętrzne: 130x69x57
Wymiary zewnętrzne: 156x95x68

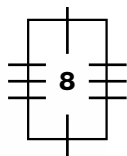
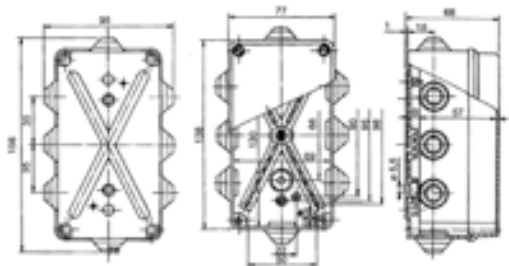

INDUSTRIAL PUSZKA N/T 198X139X82 Z 8 DŁAWICAMI

Typ	Kolor	Opak.	Waga	Indeks
Industrial IP65	szary RAL 7035	szt. 1	kg/1szt. -	2707-02

NORMA PN-EN-60670-1
Wymiary wewnętrzne: 164x99x68
Wymiary zewnętrzne: 198x139x82

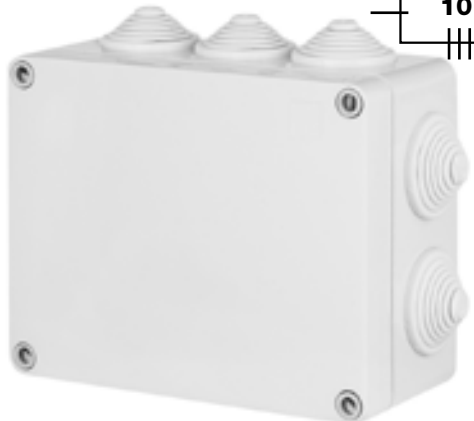
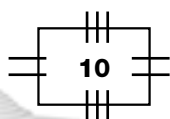
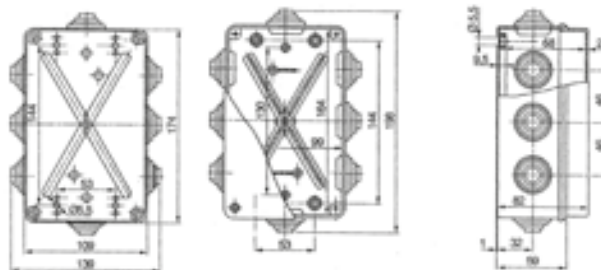

INDUSTRIAL PUSZKA N/T 198X163X80 Z 10 DŁAWICAMI

Typ	Kolor	Opak.	Waga	Indeks
Industrial IP55	szary RAL 7035	szt. 1	kg/1szt. -	2711-02

NORMA PN-EN-60670-1
Wymiary wewnętrzne: 164x129x68
Wymiary zewnętrzne: 198x163x80

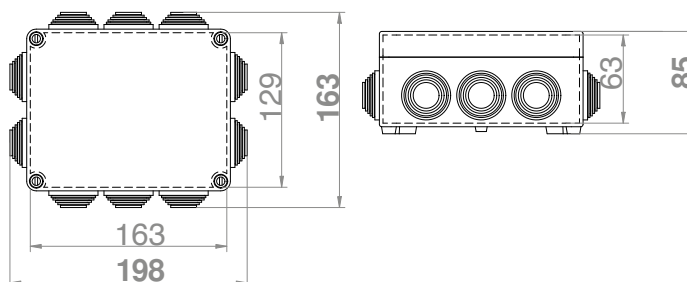

IP 55 IK 07 400 V Br Cl

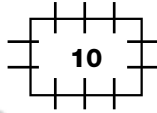

INDUSTRIAL PUSZKA N/T 249X198X81 Z 10 DŁAWICAMI

Typ	Kolor	Opak. szt.	Waga kg/1szt.	Indeks
Industrial IP55	szary RAL 7035	1	-	2716-02

NORMA PN-EN-60670-1
Wymiary wewnętrzne: 214x162x69
Wymiary zewnętrzne: 249x198x81

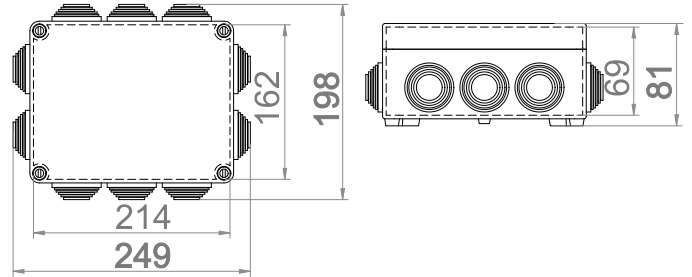

IP 55 IK 07 400 V Br Cl

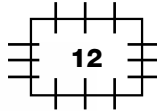

INDUSTRIAL PUSZKA N/T 305X244X126 Z 12 DŁAWICAMI

Typ	Kolor	Opak. szt.	Waga kg/1szt.	Indeks
Industrial IP55	szary RAL 7035	1	-	2721-02

NORMA PN-EN-60670-1
Wymiary wewnętrzne: 267x207x111
Wymiary zewnętrzne: 305x244x126

IP 55 IK 07 400 V Br Cl

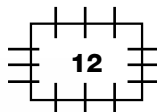

INDUSTRIAL PUSZKA N/T 305X244X168 Z 12 DŁAWICAMI

Typ	Kolor	Opak. szt.	Waga kg/1szt.	Indeks
Industrial IP55	szary RAL 7035	1	-	2722-02

NORMA PN-EN-60670-1
Wymiary wewnętrzne: 267x207x153
Wymiary zewnętrzne: 305x244x168

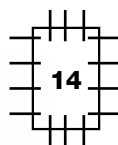

INDUSTRIAL PUSZKA N/T 342X282X115 Z 14 DŁAWICAMI

Typ	Kolor	Opak.	Waga	Indeks
		szt.	kg/1szt.	
Industrial IP55	szary RAL 7035	1	-	2723-02

NORMA PN-EN-60670-1
 Wymiary wewnętrzne: 300x240x100
 Wymiary zewnętrzne: 342x282x115

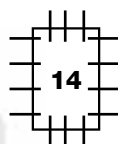

INDUSTRIAL PUSZKA N/T 342X282X165 Z 14 DŁAWICAMI

Typ	Kolor	Opak.	Waga	Indeks
		szt.	kg/1szt.	
Industrial IP55	szary RAL 7035	1	-	2724-02

NORMA PN-EN-60670-1
 Wymiary wewnętrzne: 300x240x150
 Wymiary zewnętrzne: 342x282x165

400 V PA



PŁYTKA ROZGAŁĘŻNA 4X2,5 MM²

Typ	Kolor	Opak.	Waga	Indeks
Płytki rozgałęźna	biały RAL 9003	szt. 50	kg/100 szt. 3,10	0951-00

NORMA: PN-IEC-60998-1:2006.

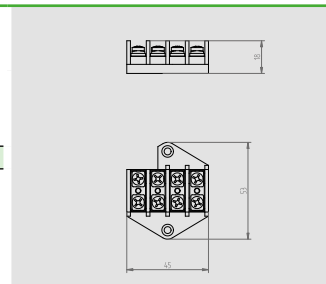

400 V PA



PŁYTKA ROZGAŁĘŻNA 4X4 MM²

Typ	Kolor	Opak.	Waga	Indeks
Płytki rozgałęźna	czarny RAL 9005	szt. 50	kg/100 szt. 3,40	0952-00

NORMA: PN-IEC-60998-1:2006.

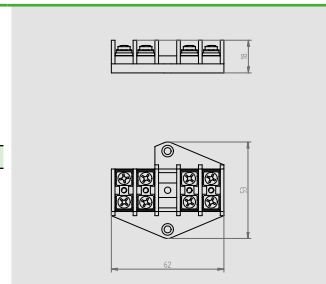

400 V PA



PŁYTKA ROZGAŁĘŻNA 4X10 MM²

Typ	Kolor	Opak.	Waga	Indeks
Płytki rozgałęźna	biały RAL 9003	szt. 25	kg/100 szt. 6,62	0953-00

NORMA: PN-IEC-60998-1:2006.

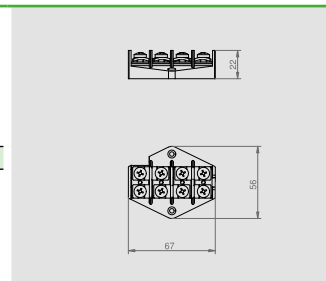

400 V PA



PŁYTKA ROZGAŁĘŻNA 4 X 16 MM²

Typ	Kolor	Opak.	Waga	Indeks
Płytki rozgałęźna	czarny RAL 9005	szt. 10	kg/100 szt. 12,30	0965-00

NORMA: PN-IEC-60998-1:2006.

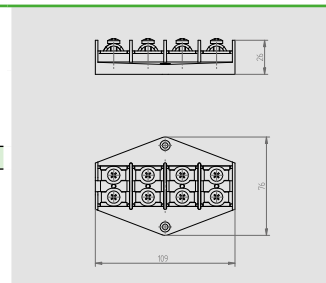

400 V PA



PŁYTKA ROZGAŁĘŻNA 5X2,5 MM²

Typ	Kolor	Opak.	Waga	Indeks
Płytki rozgałęźna	szary RAL 7035	szt. 50	kg/100 szt. 4,03	0961-00

NORMA: PN-IEC-60998-1:2006.

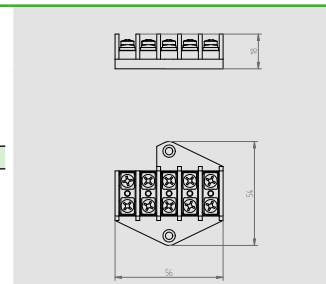

400 V PA



PŁYTKA ROZGAŁĘŻNA 5X4 MM²

Typ	Kolor	Opak.	Waga	Indeks
Płytki rozgałęźna	czarny RAL 9005	szt. 50	kg/100 szt. 3,70	0962-00

NORMA: PN-IEC-60998-1:2006.

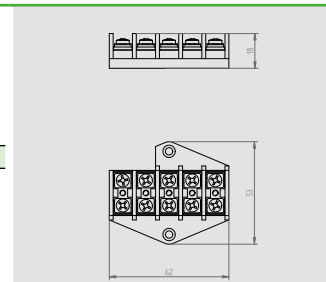

400 V PA



PŁYTKA ROZGAŁĘŻNA 5 X 10 MM²

Typ	Kolor	Opak.	Waga	Indeks
Płytki rozgałęźna	czarny RAL 9005	szt. 25	kg/100 szt. 8,80	0963-00

NORMA: PN-IEC-60998-1:2006.

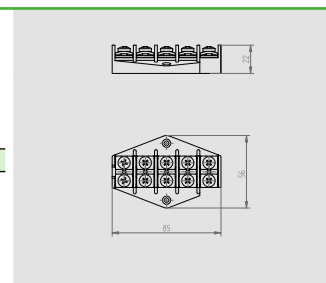

400 V PA



PŁYTKA ROZGAŁĘŻNA 5 X 16 MM²

Typ	Kolor	Opak.	Waga	Indeks
Płytki rozgałęźna	szary RAL 7035	szt. 10	kg/100 szt. 15,20	0966-00

NORMA: PN-IEC-60998-1:2006.

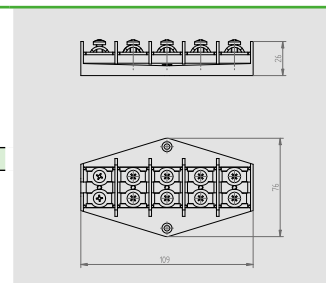

400 V PA



ZŁĄCZKA 2,5 MM²

Typ	Kolor	Opak.	Waga	Indeks
Złączka 2,5 mm ²	biały RAL 9003	szt. 100	kg/100 szt. 0,45	0940-00
	czzerwony RAL 3020	100	0,45	0940-01
	niebieski RAL 5005	100	0,45	0940-02
	zielony RAL 6001	100	0,45	0940-03
	żółty RAL 1021	100	0,45	0940-04

NORMA: PN-IEC-60998-1:2006.

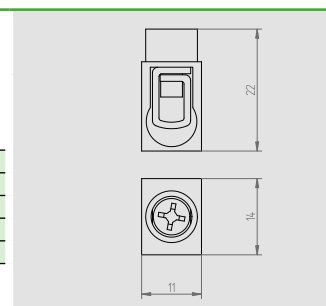

850 °C 400 V PA CE 2.5 MM²



RoHS

LISTWA ZACISKOWA LZ12 – 2.5 MM² SAMOGASNĄCA

Typ	Kolor	Opak.	Waga	Indeks
LZ12 – 2,5mm	pomarańczowy RAL 2000	szt. 100	kg/100 szt. 1,9	0930-00

Listwa zaciskowa LZ12 – 2.5 mm samogasnąca
NORMA: PN-IEC-60998-1:2006
Wymiary: A/B/C/D/E – 94/13/16/8/6mm

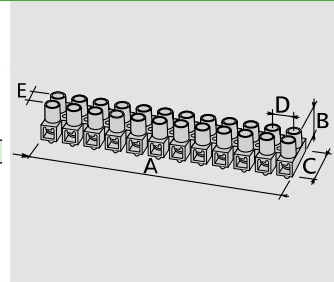

850 °C 400 V PA CE 4 MM²



RoHS

LISTWA ZACISKOWA LZ12 – 4 MM² SAMOGASNĄCA

Typ	Kolor	Opak.	Waga	Indeks
LZ12 – 4mm	pomarańczowy RAL 2000	szt. 100	kg/100 szt. 2,5	0931-00

Listwa zaciskowa LZ12 – 4 mm samogasnąca
NORMA: PN-IEC-60998-1:2006
Wymiary: A/B/C/D/E – 106/14/18/9/7mm

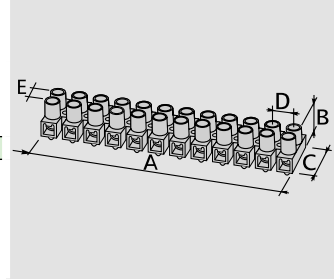

850 °C 400 V PA CE 6 MM²



RoHS

LISTWA ZACISKOWA LZ12 – 6 MM² SAMOGASNĄCA

Typ	Kolor	Opak.	Waga	Indeks
LZ12 – 6mm	pomarańczowy RAL 2000	szt. 100	kg/100 szt. 3,5	0932-00

Listwa zaciskowa LZ12 – 6 mm samogasnąca
NORMA: PN-IEC-60998-1:2006
Wymiary: A/B/C/D/E – 118/15/19/9/7mm

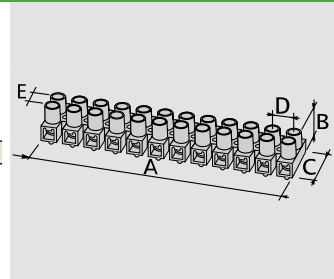

850 °C 700 V PA CE 10 MM²



RoHS

LISTWA ZACISKOWA LZ12 – 10 MM² SAMOGASNĄCA

Typ	Kolor	Opak.	Waga	Indeks
LZ12 – 10mm	pomarańczowy RAL 2000	szt. 100	kg/100 szt. 3,65	0933-00

Listwa zaciskowa LZ12 – 10 mm samogasnąca
NORMA: PN-IEC-60998-1:2006
Wymiary: A/B/C/D/E – 141/20/25/12/9mm

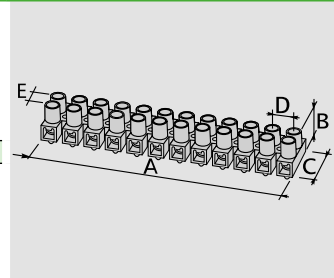

850 °C 700 V PA CE 16 MM²











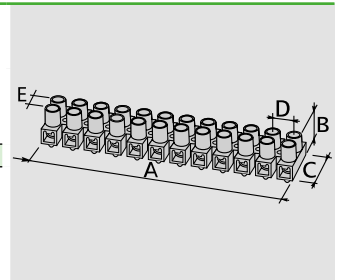

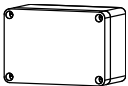
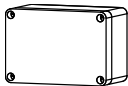
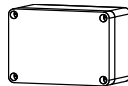
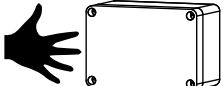
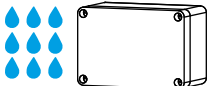

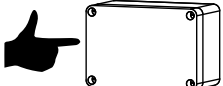
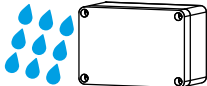
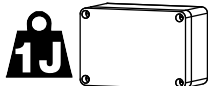
RoHS

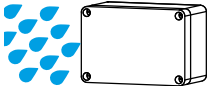
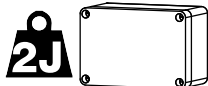
LISTWA ZACISKOWA LZ12 – 16 MM² SAMOGASNĄCA

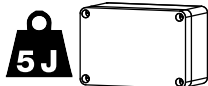
Typ	Kolor	Opak.	Waga	Indeks
LZ12 – 16mm	pomarańczowy RAL 2000	szt. 100	kg/100 szt. 3,8	0934-00

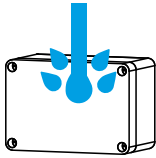
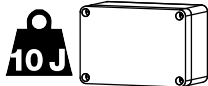
Listwa zaciskowa LZ12 – 16 mm samogasnąca
NORMA: PN-IEC-60998-1:2006
Wymiary: A/B/C/D/E – 153/22/27/13/10mm

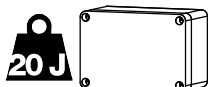
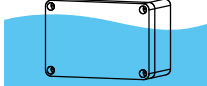

PIERWSZA CYFRA Ochrona przed ciałami stałymi		DRUGA CYFRA Ochrona przed cieczami		KOD IK Ochrona przed udarami mechanicznymi	
IP	TEST	IP	TEST	IK	TEST
0	 brak ochrony	0	 brak ochrony	00	 brak ochrony
1	 ochrona przed ciałami stałymi o średn.>50 mm (np. ręka)	1	 ochrona przed pionowo spadającymi kroplami	01-05	 udar o energii < 1 J
2	 ochrona przed ciałami stałymi o średn.>12 mm (np. palec)	2	 ochrona przed bezpośrednim natryskiem wody pod kątem do 15° od pionu.	06	 udar o energii 1 J
3	 ochrona przed ciałami stałymi o średn.>2,5 mm (np. narzędzia, drut)	3	 ochrona przed bezpośrednim natryskiem wody pod kątem do 60° od pionu	07	 udar o energii 2 J
4	 ochrona przed ciałami stałymi o średn.>1 mm (np. narzędzia, drut)	4	 ochrona przed rozpyloną wodą padającą ze wszystkich kierunków, dopuszczalny ograniczony wpływ wody	08	 udar o energii 5 J
5	 ograniczona ochrona przed dostępem pyłu	5	 ochrona przed strugami wody o niskim ciśnieniu padającymi ze wszystkich kierunków, dopuszczalny ograniczony wpływ wody	09	 udar o energii 10 J
6	 całkowita ochrona przed dostępem pyłu	6	 ochrona przed silnymi strugami wodopadającymi ze wszystkich kierunków, dopuszczalny ograniczony wpływ wody	10	 udar o energii 20 J
		7	 ochrona przed wpływem zanurzenia na głębokość od 15 cm do 1 m		
		8	 ochrona przed długotrwałym zanurzeniem pod ciśnieniem na głębokości powyżej 1m		

Stopień ochrony obudowy określany jest przez klasyfikację IP. W klasyfikacji tej występują dwie cyfry, które określają stopień ochrony przed ciałami stałymi oraz przed cieczami.

