



RSTM

Rozdzielnice siłowe



epn
NASIELSK

ELEKTRO-PLAST

Stopień ochrony	IP65* *w zależności od zainstalowanych gniazd stopień ochrony zestawu może być różny
Odporność na uderzenie	IK 08
Badanie palności próbą rozżarzonego drutu	650°C
Stopień palności	HB (UL94)
Warunki pracy	-25 °C+85 °C
Próba termiczna	70 °C
Norma	EN 60 439-1-3



Rozdzielnice siłowe RS

Rozdzielnice siłowe RS w pełni okablowane stanowią niezbędne wyposażenie każdej budowy. Oferujemy możliwość dowolnej konfiguracji gniazd w stopniach ochrony IP 44 i IP 67. Szeroka oferta dostępnych modeli obudów umożliwia stosowanie obudów przenośnych z uchwytem ułatwiającym jej przemieszczanie jak i stacjonarnych. Dodatkowym atutem jest możliwość przyłączenia do rozdzielnic więcej odbiorników. Nowe rozdzielnice RS charakteryzuje przede wszystkim wysoka jakość zastosowanych materiałów oraz niezawodność bez względu na warunki atmosferyczne co gwarantuje stopień ochrony obudów IP 65. Dodatkowym atutem jest możliwość zamówienia rozdzielni z zabezpieczeniami ochronnymi - będącymi również w ofercie ELEKTRO-PLAST.

IP44

Możliwość wykonania w stopniu ochrony od IP 44 do IP 65



6214-00

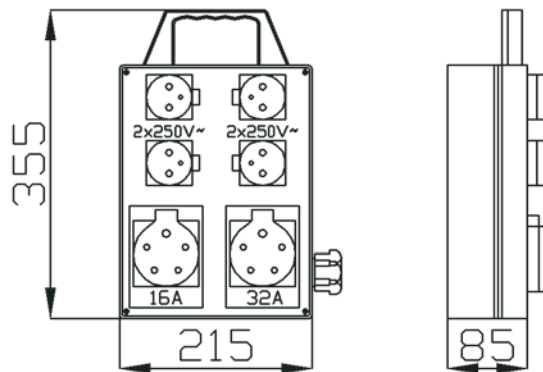

6214-00
RS przenośna
4x 2P+Z
1x 3P+N+Z 16A
1x 3P+N+Z 32A



6215-00

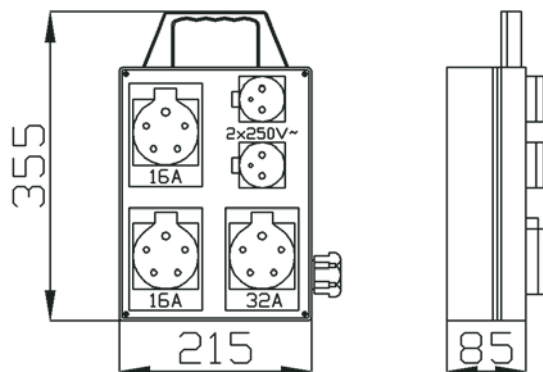

6215-00
RS przenośna
2x 2P+Z
2x 3P+N+Z 16A
1x 3P+N+Z 32A





6211-00

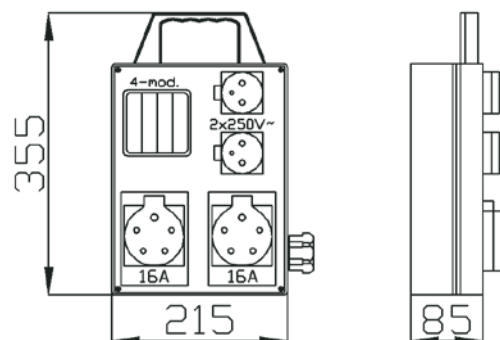

6211-00
RS przenośna 4-mod.
2x 2P+Z
2x 3P+N+Z 16A



6213-00

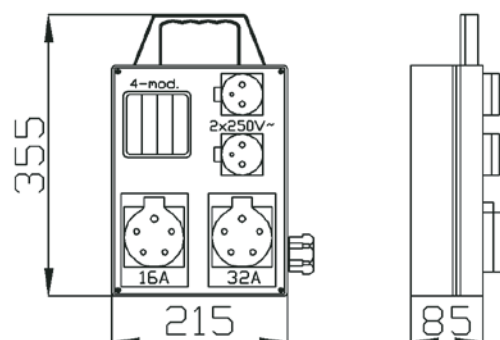

6213-00
RS przenośna 4-mod.
2x 2P+Z
1x 3P+N+Z 16A
1x 3P+N+Z 32A



6212-00

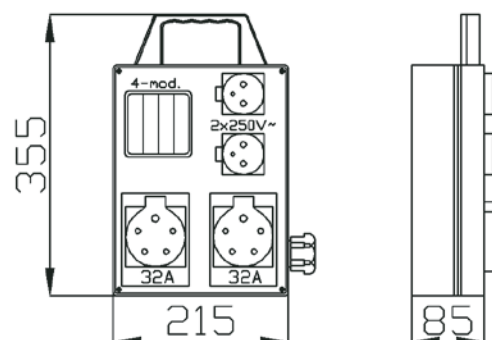

6212-00
RS przenośna 4-mod.
2x 2P+Z
2x 3P+N+Z 32A

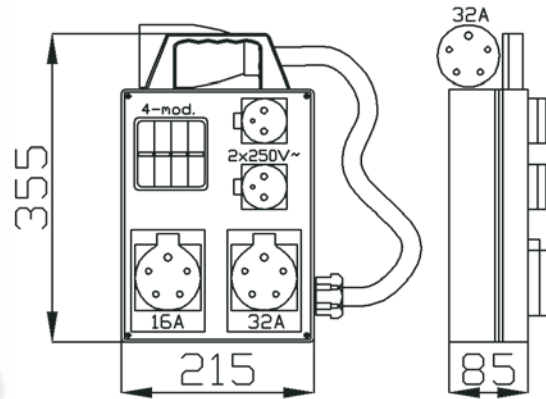

6213-10

6213-10
RS przenośna 4-mod.
2x 2P+Z
1x 3P+N+Z 16A
1x 3P+N+Z 32A
Zabezpieczenie C16+C16/3
Przewód 2m + wtyka 3P+N+Z 32A

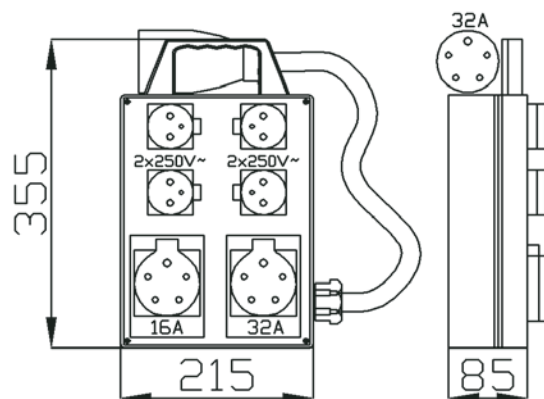

6214-10

6214-10
RS przenośna
4x 2P+Z
1x 3P+N+Z 16A
1x 3P+N+Z 32A
Przewód 2m + wtyka 3P+N+Z 32A



6231-00

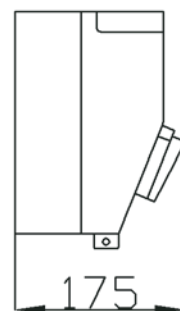
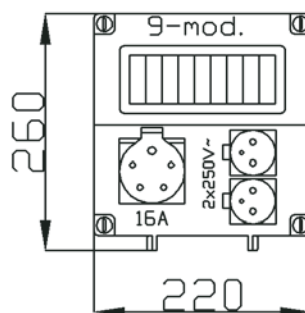

6231-00
RS 9-mod
2x 2P+Z
1x 3P+N+Z 16A



6232-00

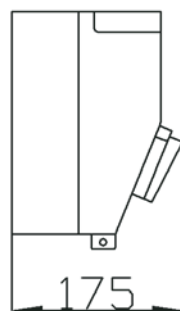
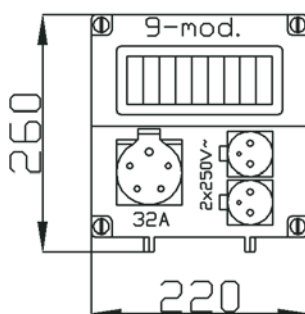

6232-00
RS 9-mod
2x 2P+Z
1x 3P+N+Z 32A

IP44



6221-00

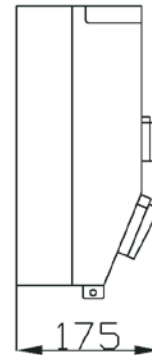
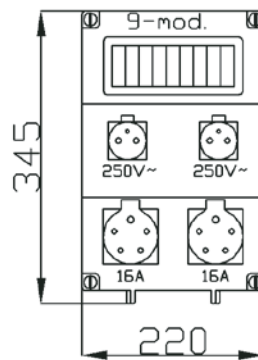

6221-00
 RS 9-mod
 2x 2P+Z
 2x 3P+N+Z 16A



6223-00

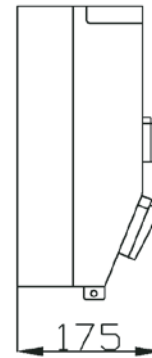
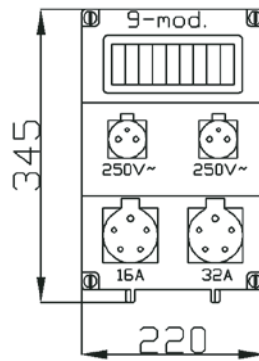

6223-00
 RS 9-mod
 2x 2P+Z
 1x 3P+N+Z 16A
 1x 3P+N+Z 32A



6222-00

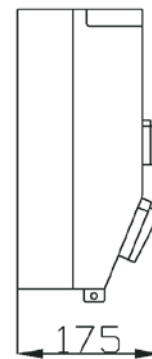
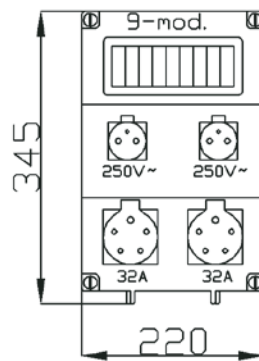

6222-00
 RS 9-mod
 2x 2P+Z
 2x 3P+N+Z 32A



6241-00

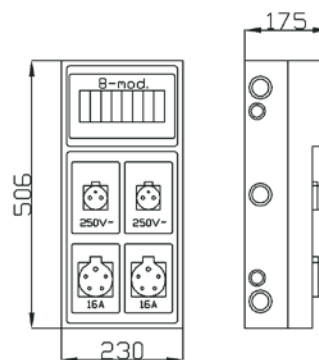

6241-00
RS 8-mod
2x 2P+Z
2x 3P+N+Z 16A



6243-00

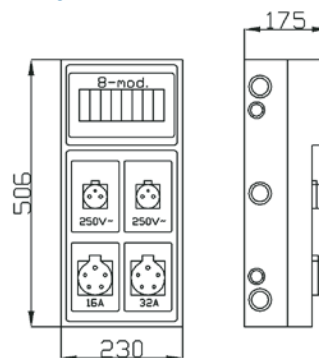

6243-00
RS 8-mod
2x 2P+Z
1x 3P+N+Z 16A
1x 3P+N+Z 32A



6242-00

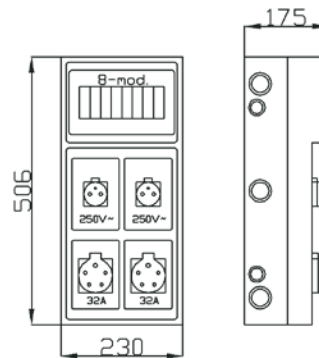

6242-00
RS 8-mod
2x 2P+Z
2x 3P+N+Z 32A



6244-00

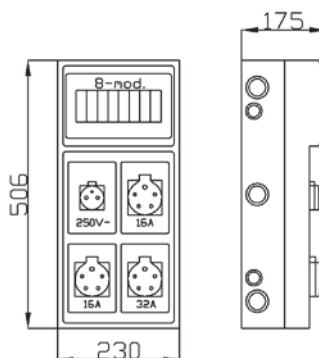

6244-00
RS 8-mod
1x 2P+Z
2x 3P+N+Z 16A
1x 3P+N+Z 32A



6251-00

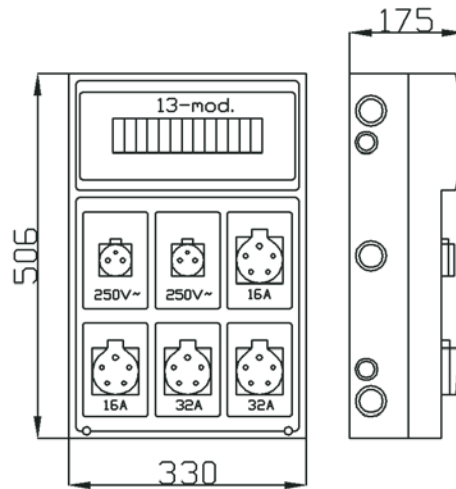

6251-00
RS 13-mod
2x 2P+Z
2x 3P+N+Z 16A
2x 3P+N+Z 32A



6258-00

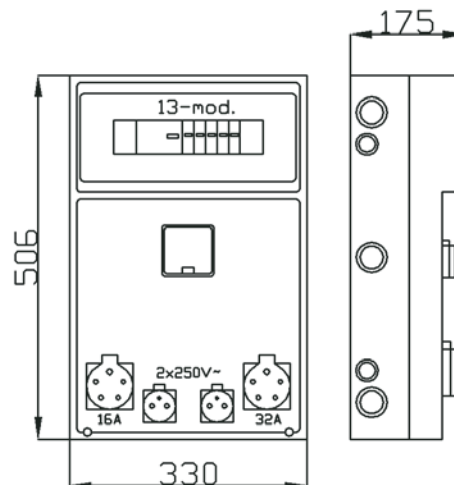

6258-00
Obudowa budowlana pod licznik
2x 2P+Z
1x 3P+N+Z 16A
1x 3P+N+Z 32A
Tablica licznikowa

Zabezpieczenia:
1x wyłącznik różnicowoprądowy EPRP6-40/4/0,03 z testerem
1x wyłącznik nadprądowy EPS6-C20/ 3-fazowy
2x wyłącznik nadprądowy EPS6-B20/ 1-fazowy

IP44



6261-00

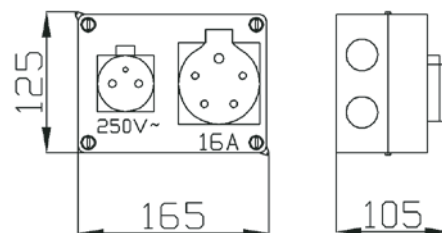

6261-00
RS 2
1x 2P+Z
1x 3P+N+Z 16A



6262-00

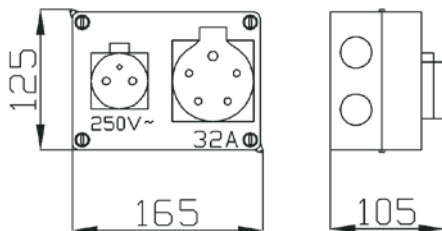

6262-00
RS 2
1x 2P+Z
1x 3P+N+Z 32A



6263-00

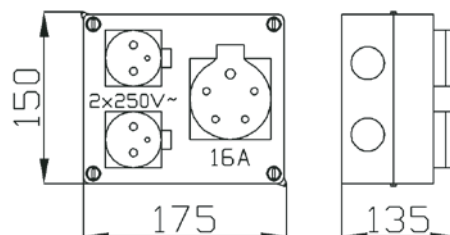

6263-00
RS 3
2x 2P+Z
1x 3P+N+Z 16A



6264-00

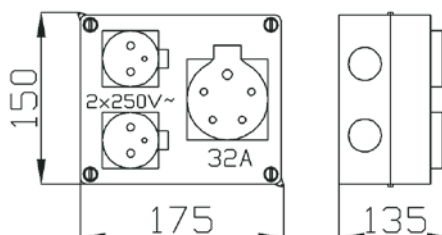

6264-00
RS 3
2x 2P+Z
1x 3P+N+Z 32A

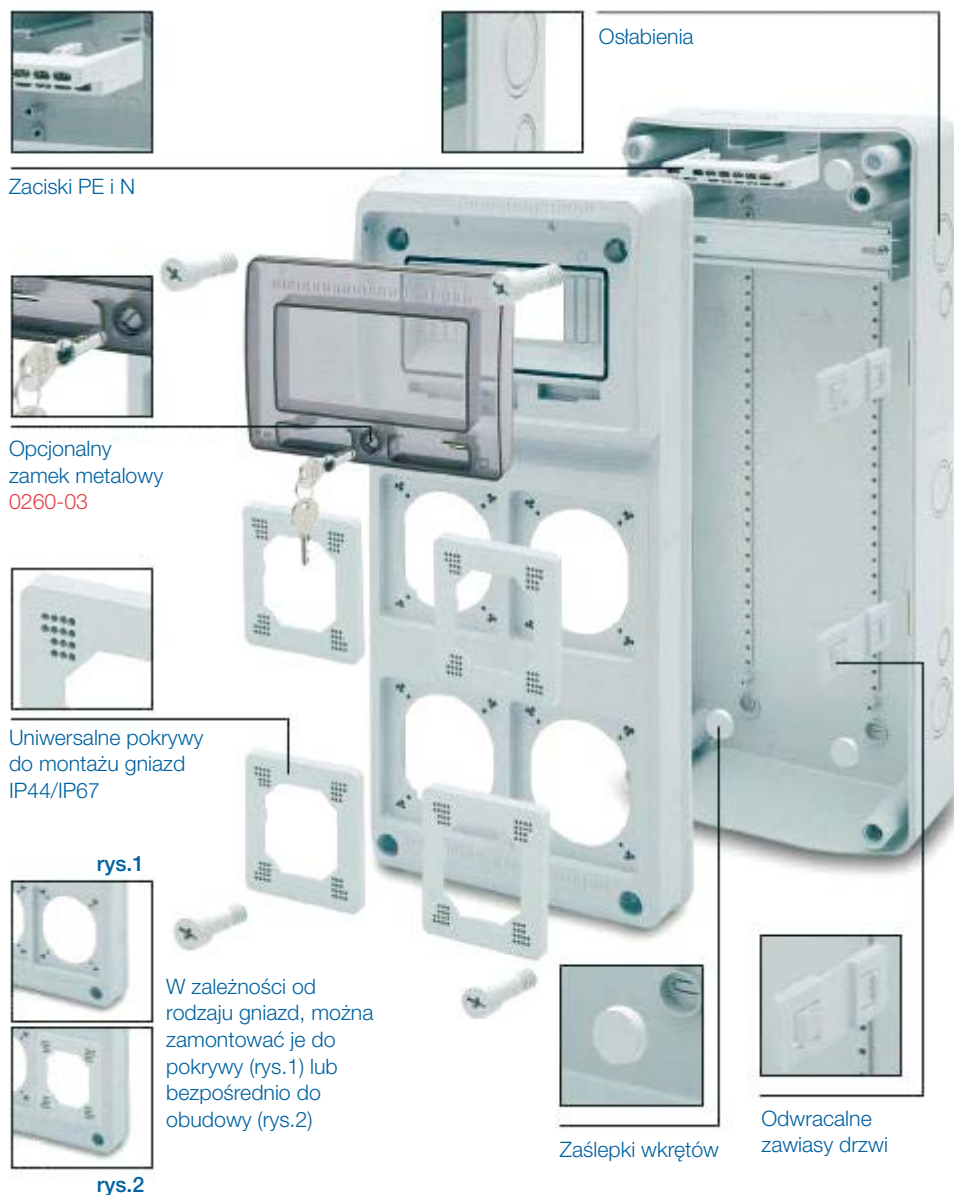

Istnieje możliwość indywidualnej konfiguracji rozdzielnic siłowych RS na specjalne zamówienie klienta.



N A S I E L S K

ELEKTRO-PLAST

ELEKTRO-PLAST

TADEUSZ CZACHOROWSKI SP. J.

05-190 Nasielsk, ul. Płońska 18

POLAND

tel. +48 (23) 693 39 00

fax +48 (23) 693 39 02

Dział handlowy

tel. +48 (23) 693 39 20

tel. +48 (23) 693 39 21

fax +48 (23) 693 39 22

www.elektro-plast.com.pl

info@elektro-plast.com.pl