

# Rozdzielnie mieszaniowe



**economic**<sup>™</sup>  
**BOX**

**EP ELEKTRO-PLAST**<sup>™</sup>  
NASIELSK

# Rozdzielnice podtynkowe **ECONOMIC BOX™ IP 40**

Stopień ochrony	IP 40
Materiał Drzwi/Obudowa	ABS / PS
Odporność na uderzenie	IK 05
Warunki pracy	-20°C +70°C
Próba termiczna	70°C
Norma	PN-EN 61439-3:2012, PN-EN 61439-1:2011



- stopień ochrony IP 40
- klasa ochrony II
- w wersji od 1 do 3 rzędów
- 6, 8, 12, 24, 36 – mod.

- w standardzie wyposażenia listwy N+PE
- drzwi w 2 kolorach
- opcja zamka na kluczyk

Obudowa w kolorze białym  
RAL 9003



Listwy zaciskowe N+PE  
w komplecie



Możliwość plombowania  
obudowy

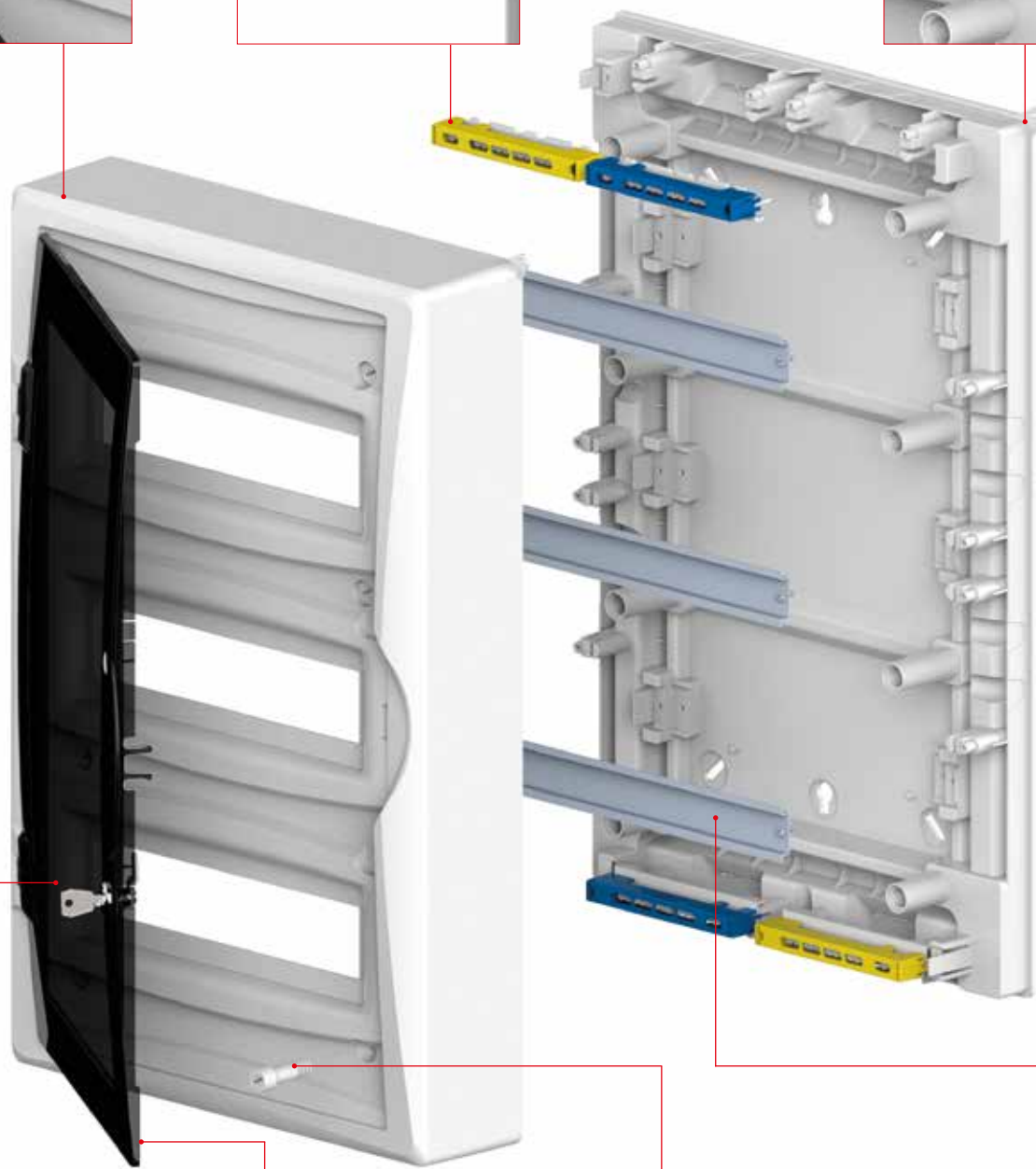

Opcjonalny zamek z kluczykiem

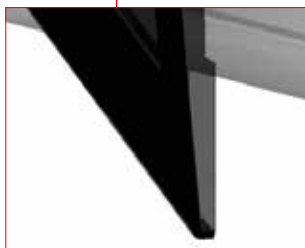

Kolor drzwi transparentny



Nowy szykbozwojny wkręt  
mocujący



Szyna stalowa TS od 12 mod.

**IP 40** **IK 05** **400 V** **PS**

**NOWOŚĆ**



## ECONOMIC BOX™ RN 1/6 IP 40 (N+PE)

Rzędy/ moduły	Typ	Kolor drzwi	Zaciski PE+N	Opak. szt.	Waga kg/1 szt.	Indeks	
						stary	nowy
1/6	RN 1/6	biały	tak	1	0,3	<b>0606-00</b>	<b>2501-00</b>
1/6	RN 1/6	transp.	tak	1	0,3	<b>0606-01</b>	<b>2501-01</b>

Stopień ochrony IP 40, napięcie znamionowe 400V  
 Listwy przyłączeniowe na wyposażeniu:  
 N 1x(3x10 mm<sup>2</sup> + 2x16 mm<sup>2</sup>)  
 PE 1x(3x10 mm<sup>2</sup> + 2x16 mm<sup>2</sup>)  
 NORMA: PN-EN 61439-3:2012, PN-EN 61439-1:2011  
 Wymiary: 192x198x96 mm

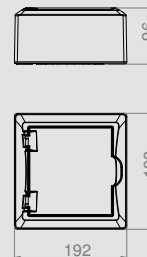

**IP 40** **IK 05** **400 V** **PS**

**NOWOŚĆ**



## ECONOMIC BOX™ RN 1/8 IP 40 (N+PE)

Rzędy/ moduły	Typ	Kolor drzwi	Zaciski PE+N	Opak. szt.	Waga kg/1 szt.	Indeks	
						stary	nowy
1/8	RN 1/8	biały	tak	1	0,45	<b>0614-00</b>	<b>2502-00</b>
1/8	RN 1/8	transp.	tak	1	0,45	<b>0614-01</b>	<b>2502-01</b>

Stopień ochrony IP 40, napięcie znamionowe 400V  
 Listwy przyłączeniowe na wyposażeniu:  
 N 1x(5x10 mm<sup>2</sup> + 2x16 mm<sup>2</sup>)  
 PE 1x(5x10 mm<sup>2</sup> + 2x16 mm<sup>2</sup>)  
 NORMA: PN-EN 61439-3:2012, PN-EN 61439-1:2011  
 Wymiary: 228x198x96 mm

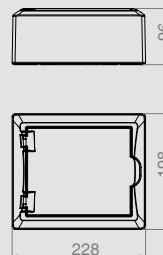

**IP 40** **IK 05** **400 V** **PS**

**NOWOŚĆ**



## ECONOMIC BOX™ RN 1/12 IP 40 (N+PE)

Rzędy/ moduły	Typ	Kolor drzwi	Zaciski PE+N	Opak. szt.	Waga kg/1 szt.	Indeks	
						stary	nowy
1/12	RN 1/12	biały	tak	1	0,76	<b>0640-00</b>	<b>2503-00</b>
1/12	RN 1/12	transp.	tak	1	0,76	<b>0640-01</b>	<b>2503-01</b>

Stopień ochrony IP 40, napięcie znamionowe 400V  
 Listwy przyłączeniowe na wyposażeniu:  
 N 1x(6x10 mm<sup>2</sup> + 8x16 mm<sup>2</sup>)  
 PE 1x(6x10 mm<sup>2</sup> + 8x16 mm<sup>2</sup>)  
 NORMA: PN-EN 61439-3:2012, PN-EN 61439-1:2011  
 Wymiary: 298x198x96 mm

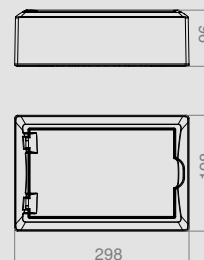

**IP 40** **IK 05** **400 V** **PS**



## ECONOMIC BOX™ RN 2/24 IP 40 (N+PE)

Rzędy/ moduły	Typ	Kolor drzwi	Zaciski PE+N	Opak. szt.	Waga kg/1 szt.	Indeks	
						stary	nowy
2/24	RN 2/24	biały	tak	1	2,00	<b>0608-00</b>	<b>2505-00</b>
2/24	RN 2/24	transp.	tak	1	2,00	<b>0608-01</b>	<b>2505-01</b>

Stopień ochrony IP 40, napięcie znamionowe 400V  
 Listwy przyłączeniowe na wyposażeniu:  
 N 2x(12x10 mm<sup>2</sup> + 2x16 mm<sup>2</sup>)  
 PE 1x(12x10 mm<sup>2</sup> + 2x16 mm<sup>2</sup>)  
 NORMA: PN-EN 61439-3:2012, PN-EN 61439-1:2011  
 Wymiary: 354x434x105 mm

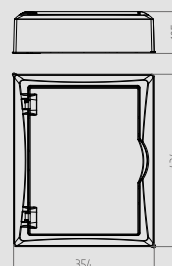

**IP 40** **IK 05** **400 V** **PS**



## ECONOMIC BOX™ RN 3/36 IP 40 (N+PE)

Rzędy/ moduły	Typ	Kolor drzwi	Zaciski PE+N	Opak. szt.	Waga kg/1 szt.	Indeks	
						stary	nowy
3/36	RN 3/36	biały	tak	1	3,0	<b>0610-00</b>	<b>2506-00</b>
3/36	RN 3/36	transp.	tak	1	3,0	<b>0610-01</b>	<b>2506-01</b>

Stopień ochrony IP 40, napięcie znamionowe 400V  
 Listwy przyłączeniowe na wyposażeniu:  
 N 2x(12x10 mm<sup>2</sup> + 2x16 mm<sup>2</sup>)  
 PE 2x(12x10 mm<sup>2</sup> + 2x16 mm<sup>2</sup>)  
 NORMA: PN-EN 61439-3:2012, PN-EN 61439-1:2011  
 Wymiary: 354x560x107 mm

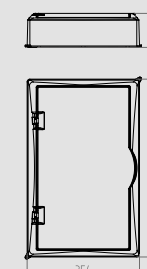

IP 40 IK 05 400 V PS



## ECONOMIC BOX™ MULTIMEDIALNA RN 2/24

Rzędy/ moduły	Typ	Kolor drzwi	Opak. szt.	Waga kg/1 szt.	Indeks	
					stary	nowy
2/24	RN 2/24	biały	1	2		<b>2505-00</b>
2/24	RN 2/24	transp.	1	2		<b>2505-01</b>

Stopień ochrony IP 40, napięcie znamionowe 400V  
Zawiera szynę TS 35 – 1szt, płytę montażową z otworami do zamocowania urządzeń.  
NORMA: PN-EN 61439-3:2012, PN-EN 61439-1:2011  
Wymiary: 360x434x105 mm

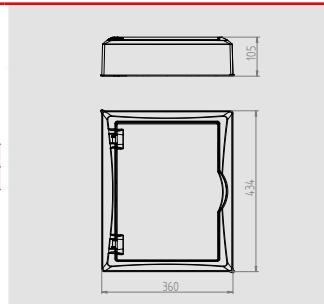

IP 40 IK 05 400 V PS



## ECONOMIC BOX™ MULTIMEDIALNA RN 3/36

Rzędy/ moduły	Typ	Kolor drzwi	Opak. szt.	Waga kg/1 szt.	Indeks	
					stary	nowy
3/36	RN 3/36	biały	1	3		<b>2506-00</b>
3/36	RN 3/36	transp.	1	3		<b>2506-01</b>

Stopień ochrony IP 40, napięcie znamionowe 400V  
Zawiera szynę TS 35 – 1szt, płytę montażową z otworami do zamocowania urządzeń.  
NORMA: PN-EN 61439-3:2012, PN-EN 61439-1:2011  
Wymiary: 354x560x107 mm

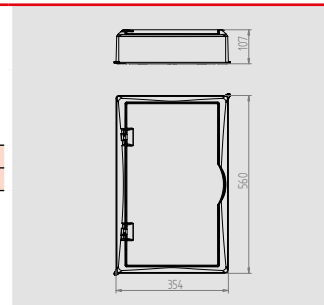

Stopień ochrony	IP 40
Materiał Drzwi/Pokrywa/Podstawa	PC/PS/PP FR
Odporność na uderzenie	IK 05
Warunki pracy	-20°C +70°C
Próba termiczna	70°C
Norma	PN-EN 61439-3:2012, PN-EN 61439-1:2011



- stopień ochrony IP 40
- klasa ochrony II
- w wersji od 1 do 3 rzędów
- 6, 8, 12, 24, 36 – mod.

- na wyposażeniu listwy N+PE
- drzwi w 2 kolorach
- nowoczesna linia wzornicza
- opcja zamka na kluczyk

Obudowa w kolorze białym RAL 9003



Stalowe utwardzane wkręty zapewniające szybki i pewny montaż



Listwy zaciskowe N+PE w komplecie



Sztywna obudowa w wersji podtynkowej.



Opcjonalny zamek z kluczykiem



Kolor drzwi transparentny



Szyny stalowe TS

**IP 40** **IK 05** **400 V** **PS**



## ECONOMIC BOX™ RP 1/6 IP 40 (N+PE)

Rzędy/ moduły	Typ	Kolor drzwi	Zaciski PE+N	Opak. szt.	Waga kg/1 szt.	Indeks	
						stary	nowy
1/6	RP 1/6	biały	tak	1	0,6	<b>0680-00</b>	<b>2511-00</b>
1/6	RP 1/6	transp.	tak	1	0,6	<b>0680-01</b>	<b>2511-01</b>

Stopień ochrony IP 40, napięcie znamionowe 400V  
 Listwy przyłączeniowe na wyposażeniu:  
 N 1x(3x10 mm<sup>2</sup> + 2x16 mm<sup>2</sup>)  
 PE 1x(3x10 mm<sup>2</sup> + 2x16 mm<sup>2</sup>)  
 NORMA: PN-EN 61439-3:2012, PN-EN 61439-1:2011  
 Wymiary: 270x240x106 mm

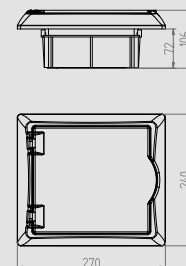

**IP 40** **IK 05** **400 V** **PS**



## ECONOMIC BOX™ RP 1/8 IP 40 (N+PE)

Rzędy/ moduły	Typ	Kolor drzwi	Zaciski PE+N	Opak. szt.	Waga kg/1 szt.	Indeks	
						stary	nowy
1/8	RP 1/8	biały	tak	1	0,7	<b>0681-00</b>	<b>2512-00</b>
1/8	RP 1/8	transp.	tak	1	0,7	<b>0681-01</b>	<b>2512-01</b>

Stopień ochrony IP 40, napięcie znamionowe 400V  
 Listwy przyłączeniowe na wyposażeniu:  
 N 1x(5x10 mm<sup>2</sup> + 2x16 mm<sup>2</sup>)  
 PE 1x(5x10 mm<sup>2</sup> + 2x16 mm<sup>2</sup>)  
 NORMA: PN-EN 61439-3:2012, PN-EN 61439-1:2011  
 Wymiary: 300x240x102 mm

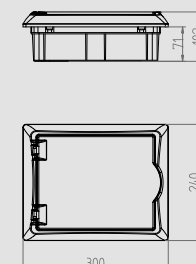

**IP 40** **IK 05** **400 V** **PS**



## ECONOMIC BOX™ RP 1/12 IP 40 (N+PE)

Rzędy/ moduły	Typ	Kolor drzwi	Zaciski PE+N	Opak. szt.	Waga kg/1 szt.	Indeks	
						stary	nowy
1/12	RP 1/12	biały	tak	1	1,1	<b>0682-00</b>	<b>2513-00</b>
1/12	RP 1/12	transp.	tak	1	1,1	<b>0682-01</b>	<b>2513-01</b>

Stopień ochrony IP 40, napięcie znamionowe 400V  
 Listwy przyłączeniowe na wyposażeniu:  
 N 1x(12x10 mm<sup>2</sup> + 2x16 mm<sup>2</sup>)  
 PE 1x(12x10 mm<sup>2</sup> + 2x16 mm<sup>2</sup>)  
 NORMA: PN-EN 61439-3:2012, PN-EN 61439-1:2011  
 Wymiary: 360x240x106 mm

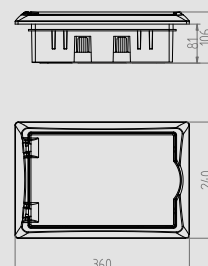

**IP 40** **IK 05** **400 V** **PS**



## ECONOMIC BOX™ RP 2/24 IP 40 (N+PE)

Rzędy/ moduły	Typ	Kolor drzwi	Zaciski PE+N	Opak. szt.	Waga kg/1 szt.	Indeks	
						stary	nowy
2/24	RP 2/24	biały	tak	1	1,6	<b>0684-00</b>	<b>2515-00</b>
2/24	RP 2/24	transp.	tak	1	1,6	<b>0684-01</b>	<b>2515-01</b>

Stopień ochrony IP 40, napięcie znamionowe 400V  
 Listwy przyłączeniowe na wyposażeniu:  
 N 2x(12x10 mm<sup>2</sup> + 2x16 mm<sup>2</sup>)  
 PE 1x(12x10 mm<sup>2</sup> + 2x16 mm<sup>2</sup>)  
 NORMA: PN-EN 61439-3:2012, PN-EN 61439-1:2011  
 Wymiary: 350x430x95 mm

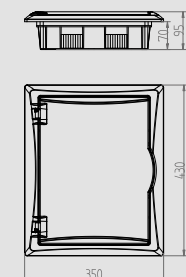

**IP 40** **IK 05** **400 V** **PS**



## ECONOMIC BOX™ RP 3/36 IP 40 (N+PE)

Rzędy/ moduły	Typ	Kolor drzwi	Zaciski PE+N	Opak. szt.	Waga kg/1 szt.	Indeks	
						stary	nowy
3/36	RP 3/36	biały	tak	1	2,4	<b>0685-00</b>	<b>2516-00</b>
3/36	RP 3/36	transp.	tak	1	2,4	<b>0685-01</b>	<b>2516-01</b>

Stopień ochrony IP 40, napięcie znamionowe 400V  
 Listwy przyłączeniowe na wyposażeniu:  
 N 2x(12x10 mm<sup>2</sup> + 2x16 mm<sup>2</sup>)  
 PE 2x(12x10 mm<sup>2</sup> + 2x16 mm<sup>2</sup>)  
 NORMA: PN-EN 61439-3:2012, PN-EN 61439-1:2011  
 Wymiary: 350x560x102 mm

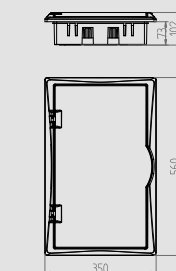







**ELEKTRO-PLAST**

05-190 Nasielsk, ul. Płońska 18  
Poland  
tel. +48 (023) 693 39 00  
fax +48 (023) 693 39 02

**Sales department**

tel. +48 (023) 693 39 20  
tel. +48 (023) 693 39 21  
fax +48 (023) 693 39 22



ELEKTRO-PLAST zastrzega sobie prawo do dokonywania zmian technicznych bądź modyfikacji zawartości niniejszego dokumentu bez uprzedniego powiadomienia.  
© Copyright 2015 **ELEKTRO-PLAST**. Wszelkie prawa oraz wybrane wzory zastrzeżone. Wydanie 1.2016

[www.elektro-plast.com.pl](http://www.elektro-plast.com.pl)  
[info@elektro-plast.com.pl](mailto:info@elektro-plast.com.pl)